



"Estoi" con Toi



Somos los primeros en sacar lo último
catálogo piscinas 2014





LINER: PVC con tratamiento anti-ultravioleta.

ESTRUCTURA: Madera de pino del norte. Fácil instalación. Madera tratada en autoclave IV y tintada.

ESCALERA: NATIVA - Escalera exterior de madera de 3 peldaños. Interior acero inox. 3 peldaños.
BARRICA - Escalera lacada en blanco de 8 peldaños.

FILTRO: Filtro de Arena y skimmer.



LINER : PVC avec traitement anti-UV.

STRUCTURE : Bois de pin du nord. Installation facile. Bois traité en autoclave IV et teinté.

ÉCHELLE : NATIVA - Échelle extérieure bois avec 3 échelons. Acier inoxydable Intérieur. 3 échelons.
BARRICA - une échelle laquée blanche 8 échelons.

FILTRE : filtre à sable et skimmer.



LINER: PVC. UV resistant.

STRUCTURE: Made of northern pine tree. Easy to install. Autoclave level IV treatment and tinted wood.

LADDER: NATIVA - Outside ladder made of wood with 3 steps. Interior stainless steel. 3 steps.
BARRICA - a lacquered white ladder 8 steps.

FILTER: Sand filter and skimmer.

PISCINAS DE MADERA - WOODEN POOLS - PISCINES BOIS

Piscinas fáciles de montar - Easy to assembly pools - Facile à assembler piscines

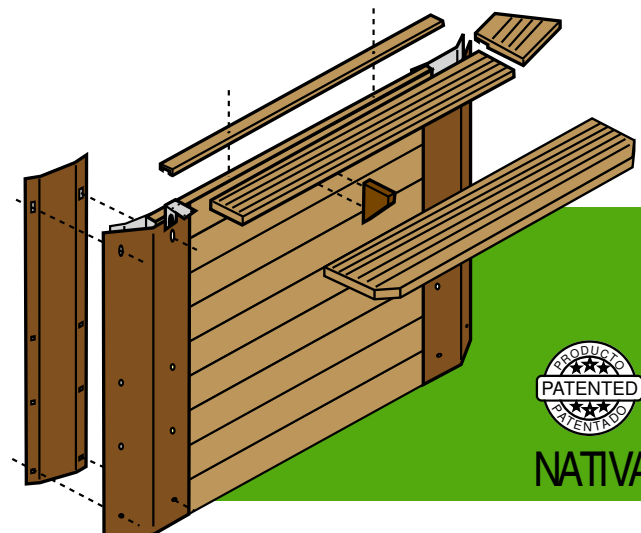
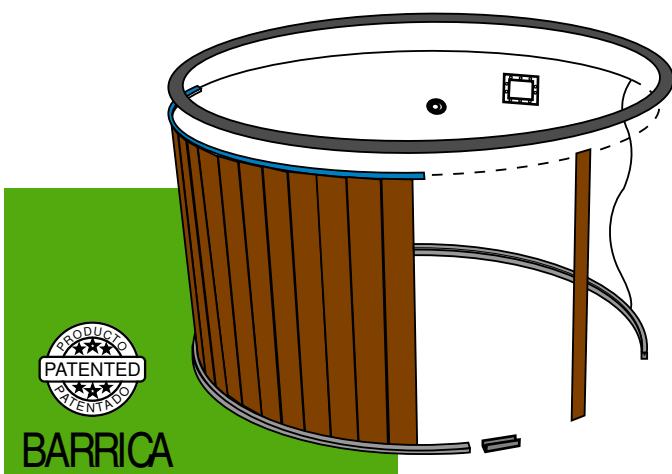

SERIE
NATIVA - 100% Madera



CIRCULAR

MOD. Ø5,50

Piscina de madera con refuerzos metálicos en las esquinas. La más sólida del mercado, 5 años de garantía decreciente en la estructura de madera.

Wooden pool with metal reinforcements in the corners. The strongest in the market, declining 5 year warranty on wood structure.

Piscine en bois avec renforts métalliques dans les coins. Le plus fort sur le marché, la baisse des 5 ans de garantie sur la structure en bois.

8984	270 cm	240 cm	125 cm	6.000 l.	4 m³/h	248 kg	✓	35 mm
8985	390 cm	350 cm	125 cm	10.100 l.	4 m³/h	485 kg	✓	35mm



Filtro 4 m³/h
250 W
1/4 hp



Escalera:
-Exterior
madera 3 peldaños.
-Interior Inoxidable
3 peldaños.



Madera tratada en autoclave 4.



MODELO PATENTADO

SERIE BARRICA - Recubierta en madera.



¡La piscina más fácil de montar de su segmento!
 ¡The pool easiest to assemble in its class!
 ¡La piscine plus facile de monter dans sa catégorie!



CIRCULAR

MOD.8852

Piscina de acero recubierta con listones de madera mediante guías perimetrales. Fácil y rápida instalación. Madera tratada en autoclave 4.

Swimming steel coated with wood slats by Perimeter rails. Quick and easy installation. Autoclaved Wood 4.

Piscine acier avec recouvert lattes de bois par des rails de périmètre. Installation rapide et facile. Bois autoclave 4.

8851	355 cm	350 cm	120 cm	10.580 l.	4 m ³ /h	180 kg	✓	10 mm
8852	465 cm	460 cm	120 cm	18.000 l.	4 m ³ /h	200 kg	✓	10 mm
8853	465 cm	460 cm	120 cm	18.000 l.	7 m ³ /h	206 kg	✓	10 mm
8854	555 cm	550 cm	120 cm	26.120 l.	4 m ³ /h	238 kg	✓	10 mm
8855	555 cm	550 cm	120 cm	26.120 l.	7 m ³ /h	245 kg	✓	10 mm



Filtro 4 m³/h
250 W
1/4 hp



Filtro 7 m³/h
400 W
1/2 hp



Escalera de 8 peldaños





Alta calidad de acabados.



MODELO PATENTADO

PISCINAS DE PARED DE ACERO

 LINER: PVC con tratamiento anti-ultravioleta.
 PARED: Acero lacado y cierre con doble fila de tornillos para mayor seguridad.
 PERFILES: Perfiles metálicos blancos (15cm / 14cm).
 ESCALERA: Según la serie, ésta va dotada de una escalera con plataforma, una escalera lacada en blanco o una escalera galvanizada
 FILTRO: Filtro de arena o filtro de cartucho.
 ACCESORIOS SERIE DECOH!POOLS: Funda decorativa.

 LINER : PVC et traitement anti-UV.
 PAROI : acier laqué et fermeture assurée par une double ligne de vis.
 PROFILÉS : Profilés métalliques blancs (15cm / 14cm)
 ÉCHELLE : Les séries sont dotées une échelle avec plate-forme, une échelle laquée blanche ou une échelle galvanisée.
 FILTRE : Filtre à sable ou filtre à cartouche.
 ACCESSOIRES SÉRIE DECOH !POOLS : Housse décorative.

 LINER: PVC, UV resistant.
 WALL: Lacquered steel, closed with double screw line for more security.
 SECTIONS: White steel sections (15cm / 14cm).
 LADDER: Series equipped either a ladder with platform, a lacquered white ladder or a galvanized ladder
 FILTER: Sand filter or cartridge filter.
 ACCESSORIES SERIES DECOH!POOLS: Decorative cover.

Espacio, volumen y tiempo necesario - Space, volume and time - Espace, volume et temps

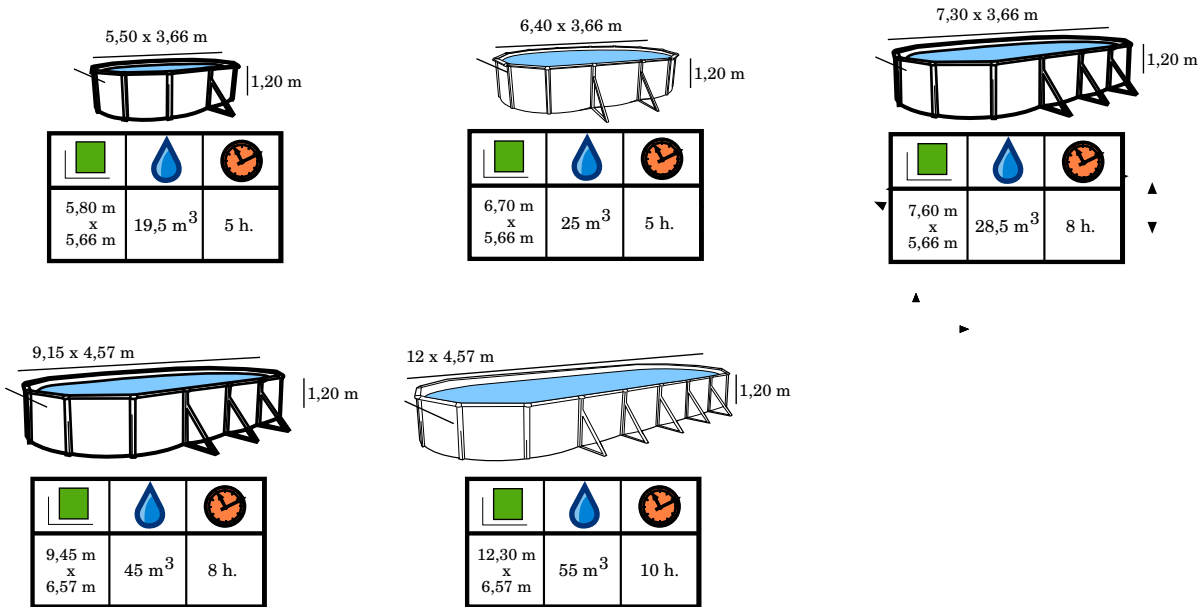

DECOH!POOLS

Funda decorativa - Decorative Cover - Housse décorative



CAMUFLAJE



BOSQ UE



VEIA



EINICA



MURO



ROCALLA



PIEDRA GRIS



MOSAICO

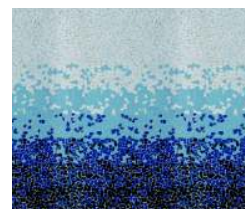

TRENCADIS



























OCEANO

SISTEMAS DE FILTRACIÓN- FILTRATION SYSTEMS - SYSTÈMES DE FILTRATION

Equipos de limpieza recomendados en función del sistema de filtración que lleva la piscina.

Recommended cleaning equipment based filtration system that takes the pool.

Système de filtration à base de matériel de nettoyage qui prend la piscine recommandée.

SISTEMA DE FILTRACIÓN	EQUIPO DE LIMPIEZA RECOMENDADO			
 Filtro de cartucho 2 m³ /h	 Ventury ref.4858	 Limpia fondos manual de émbolo ref.4864		
 Skimmer filtrante 3,6 m³ /h	 Ventury ref.4858	 Limpia fondos manual de émbolo ref.4864		
 Filtro de arena 4 m³ /h - 1/4 hp	 Kit limpia fondos ref.4893	 PEQUEÑA ANACONDA (4867)		
 Filtro de arena 7 m³ /h - 1/2 hp	 Kit limpia fondos ref.4893	 PEQUEÑA ANACONDA (4867)		
 Filtro de arena 8 m³ /h - 3/4 hp	 + Ø 38 mm	 Limpia fondos automático MARIQUITA (4865)		
 Filtro de arena 10 m³ /h - 1 hp	 + Ø 38 mm	 Limpia fondos automático MARIQUITA (4865)	 Limpia fondos automático VENTOSA (4857)	<div style="border: 1px solid black; padding: 5px;"> ELECTRICO (4866) -Conexión eléctrica. -No depende de la potencia de la bomba. -Válido para todas las piscinas. </div>
 Filtro de arena 15 m³ /h - 1,3 hp	 + Ø 38 mm	 Limpia fondos automático MARIQUITA (4865)	 Limpia fondos automático VENTOSA (4857)	 Robot Limpia fondos ELECTRICO (4866)

'Está' con Tó



CONSEJOS:

-Lea detenidamente el manual de instrucciones de su equipo de filtración antes de ponerlo en marcha.

-Para mantener el agua limpia se necesita un mantenimiento diario de la piscina.

-El sistema de FILTRACIÓN debe complementarse con el uso de PRODUCTOS QUÍMICOS.

-Compruebe que el pH de la piscina sea el correcto.

SERIE CAMUFLAJE

8670	550X366	120 cm	19.500 l.	4 m³/h	177 kg	-	✓	2+10	-	-
8671	640X366	120 cm	25.000 l.	4 m³/h	212 kg	-	✓	4+10	-	-
8672	730X366	120 cm	28.500 l.	4 m³/h	238 kg	✓	-	6+10	-	-
8673	915X457	120 cm	45.000 l.	7 m³/h	312 kg	✓	-	6+10	-	-
8674	915X457	120 cm	45.000 l.	8 m³/h	320 kg	✓	-	6+10	-	-



Filtro 4 m³/h
250 W
1/4 hp



Filtro 7 m³/h
400 W
1/2 hp



Filtro 8 m³/h
450 W
3/4 hp



Escalera de
8 peldaños



Escalera de
plataforma

8675	350 cm	120 cm	10.580 l.	4 m³/h	129 kg	✓	10 uni.	-	-
8676	460 cm	120 cm	18.000 l.	4 m³/h	150 kg	✓	10 uni.	-	-
8677	550 cm	120 cm	26.120 l.	4 m³/h	171 kg	✓	12 uni.	-	-
8681	640 cm	120 cm	35.370 l.	7 m³/h	238 kg	✓	14 uni.	-	-



Filtro 4 m³/h
250 W
1/4 hp



Filtro 7 m³/h
400 W
1/2 hp



Escalera de
8 peldaños

8678	350 cm	90 cm	8.150 l.	2 m³/h	49 kg	✓	✓
8679	400 cm	90 cm	10.670 l.	2 m³/h	55 kg	✓	✓
8680	450 cm	90 cm	13.500 l.	2 m³/h	61 kg	✓	✓



Filtro 2 m³/h



Escalera
galvanizada

SERIE
CAMUFLAJE

Piscinas de banda de acero lacado, cubiertas por una funda decorativa de polietileno de alta densidad y calidad fotográfica.

Painted steel pools, covered with a decorative band HDPE and photographic quality.

Piscines en acier laquées, couvertes par une bande décorative PEHD et avec qualité photographique.

OVALADA

MOD. 8672



CIRCULAR

MOD. 8677



PROMO

MOD. 8679



Decoh!pool
PATENTADO
PATENTED

SERIE BOSQUE

8326	550X366	120 cm	19.500 l.	4 m³/h	177 kg	-	✓	2+10	-	-
8327	640X366	120 cm	25.000 l.	4 m³/h	212 kg	-	✓	4+10	-	-
8328	730X366	120 cm	28.500 l.	4 m³/h	238 kg	✓	-	6+10	-	-
8329	915X457	120 cm	45.000 l.	7 m³/h	312 kg	✓	-	6+10	-	-
8330	915X457	120 cm	45.000 l.	8 m³/h	320 kg	✓	-	6+10	-	-



Filtro 4 m³/h
250 W
1/4 hp



Filtro 7 m³/h
400 W
1/2 hp



Filtro 8 m³/h
450 W
3/4 hp



Escalera de
8 peldaños



Escalera de
plataforma

8324	350 cm	120 cm	10.580 l.	4 m³/h	129 kg	✓	10 uni.	-	-
8323	460 cm	120 cm	18.000 l.	4 m³/h	150 kg	✓	10 uni.	-	-
8325	550 cm	120 cm	26.120 l.	4 m³/h	171 kg	✓	12 uni.	-	-
8321	640 cm	120 cm	35.370 l.	7 m³/h	238 kg	✓	14 uni.	-	-



Filtro 4 m³/h
250 W
1/4 hp



Filtro 7 m³/h
400 W
1/2 hp



Escalera de
8 peldaños

8318	350 cm	90 cm	8.150 l.	2 m³/h	49 kg	✓	✓
8319	400 cm	90 cm	10.670 l.	2 m³/h	55 kg	✓	✓
8320	450 cm	90 cm	13.500 l.	2 m³/h	61 kg	✓	✓



Filtro 2 m³/h



Escalera
galvanizada

SERIE
BOSQUE

Piscinas de banda de acero lacado, cubiertas por una funda decorativa de polietileno de alta densidad y calidad fotográfica.

Painted steel pools, covered with a decorative band HDPE and photographic quality.

Piscines en acier laquées, couvertes par une bande décorative PEHD et avec qualité photographique.

OVALADA

MOD. 8328



CIRCULAR

MOD. 8325









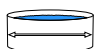
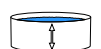

PROMO

MOD. 8319

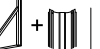

PATENTADO
Decoh!pool
PATENTED

SERIE VETA

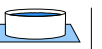
										
8396	550X366	120 cm	19.500 l.	4 m³/h	177 kg	-	✓	2+10	-	-
8397	640X366	120 cm	25.000 l.	4 m³/h	212 kg	-	✓	4+10	-	-
8398	730X366	120 cm	28.500 l.	4 m³/h	238 kg	✓	-	6+10	-	-
8399	915X457	120 cm	45.000 l.	7 m³/h	312 kg	✓	-	6+10	-	-
8400	915X457	120 cm	45.000 l.	8 m³/h	320 kg	✓	-	6+10	-	-

8041	550X366	120 cm	19.500 l.	4 m³/h	179 kg	-	✓	2+10	✓	✓
8042	640X366	120 cm	25.000 l.	4 m³/h	217 kg	-	✓	4+10	✓	✓
8043	730X366	120 cm	28.500 l.	4 m³/h	281 kg	✓	-	6+10	✓	✓
8044	915X457	120 cm	45.000 l.	7 m³/h	322 kg	✓	-	6+10	✓	✓
8045	915X457	120 cm	45.000 l.	8 m³/h	331 kg	✓	-	6+10	✓	✓



Filtro 4 m³/h
250 W
1/4 hp

Filtro 7 m³/h
400 W
1/2 hp







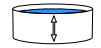
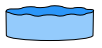

Filtro 8 m³/h
450 W
3/4 hp

Escalera de
8 peldaños

Escalera de
plataforma

Kit de verano

Tapiz

										
8393	350 cm	120 cm	10.580 l.	4 m³/h	129 kg	✓	10 uni.	-	-	-
8394	460 cm	120 cm	18.000 l.	4 m³/h	150 kg	✓	10 uni.	-	-	-
8395	550 cm	120 cm	26.120 l.	4 m³/h	171 kg	✓	12 uni.	-	-	-
8401	640 cm	120 cm	35.370 l.	7 m³/h	238 kg	✓	14 uni.	-	-	-

8031	350 cm	120 cm	10.580 l.	4 m³/h	132 kg	✓	10 uni.	✓	✓	-
8032	460 cm	120 cm	18.000 l.	4 m³/h	155 kg	✓	10 uni.	✓	✓	-
8033	550 cm	120 cm	26.120 l.	4 m³/h	180 kg	✓	12 uni.	✓	✓	-
8034	640 cm	120 cm	35.370 l.	7 m³/h	247 kg	✓	14 uni.	✓	✓	-









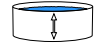

Filtro 4 m³/h
250 W
1/4 hp

Filtro 7 m³/h
400 W
1/2 hp

Escalera de
8 peldaños

Kit de verano

Tapiz

										
8601	350 cm	90 cm	8.150 l.	2 m³/h	49 kg	✓	✓	-	-	-
8602	400 cm	90 cm	10.670 l.	2 m³/h	55 kg	✓	✓	-	-	-
8603	450 cm	90 cm	13.500 l.	2 m³/h	61 kg	✓	✓	-	-	-



Filtro 2 m³/h

Escalera
galvanizada

SERIE
VETA

Piscinas de banda de acero lacado, cubiertas por una funda decorativa de polietileno de alta densidad y calidad fotográfica.

Painted steel pools, covered with a decorative band HDPE and photographic quality.

Piscines en acier laquées, couvertes par une bande décorative PEHD et avec qualité photographique.

OVALADA

MCD. 8398



CIRCULAR

MCD. 8395



PROMO









MCD. 8602



PATENTADO
Decoh!pool
PATENTED

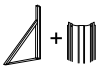

SERIE ETNICA

										
8116	550X366	120 cm	19.500 l.	4 m³/h	177 kg	-	✓	2+10	-	-
8117	640X366	120 cm	25.000 l.	4 m³/h	212 kg	-	✓	4+10	-	-
8118	730X366	120 cm	28.500 l.	4 m³/h	238 kg	✓	-	6+10	-	-
8119	915X457	120 cm	45.000 l.	7 m³/h	312 kg	✓	-	6+10	-	-
8120	915X457	120 cm	45.000 l.	8 m³/h	320 kg	✓	-	6+10	-	-



Filtro 4 m³/h
250 W
1/4 hp



Filtro 7 m³/h
400 W
1/2 hp











Filtro 8 m³/h
450 W
3/4 hp



Escalera de
8 peldaños

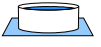

Escalera de
plataforma

									
8106	350 cm	120 cm	10.580 l.	4 m³/h	129 kg	✓	10 uni.	-	-
8107	460 cm	120 cm	18.000 l.	4 m³/h	150 kg	✓	10 uni.	-	-
8108	550 cm	120 cm	26.120 l.	4 m³/h	171 kg	✓	12 uni.	-	-
8109	640 cm	120 cm	35.370 l.	7 m³/h	238 kg	✓	14 uni.	-	-









Filtro 4 m³/h
250 W
1/4 hp



Filtro 7 m³/h
400 W
1/2 hp



Escalera de
8 peldaños

							
8100	350 cm	90 cm	8.150 l.	2 m³/h	49 kg	✓	✓
8101	400 cm	90 cm	10.670 l.	2 m³/h	55 kg	✓	✓
8102	450 cm	90 cm	13.500 l.	2 m³/h	61 kg	✓	✓



Filtro 2 m³/h



Escalera
galvanizada

SERIE
ETNICA

Piscinas de banda de acero lacado, cubiertas por una funda decorativa de polietileno de alta densidad y calidad fotográfica.

Painted steel pools, covered with a decorative band HDPE and photographic quality.

Piscines en acier laquées, couvertes par une bande décorative PEHD et avec qualité photographique.

OVALADA

MOD. 8118



CIRCULAR

MOD. 8108



PROMO

MOD. 8101



PATENTADO
Decoh!pool
PATENTED

SERIE MURO

8536	550X366	120 cm	19.500 l.	4 m³/h	177 kg	-	✓	2+10	-	-
8537	640X366	120 cm	25.000 l.	4 m³/h	212 kg	-	✓	4+10	-	-
8538	730X366	120 cm	28.500 l.	4 m³/h	238 kg	✓	-	6+10	-	-
8539	915X457	120 cm	45.000 l.	7 m³/h	312 kg	✓	-	6+10	-	-
8540	915X457	120 cm	45.000 l.	8 m³/h	320 kg	✓	-	6+10	-	-



Filtro 4 m³/h
250 W
1/4 hp



Filtro 7 m³/h
400 W
1/2 hp



Filtro 8 m³/h
450 W
3/4 hp



Escalera de
8 peldaños



Escalera de
plataforma

8526	350 cm	120 cm	10.580 l.	4 m³/h	129 kg	✓	10 uni.	-	-
8527	460 cm	120 cm	18.000 l.	4 m³/h	150 kg	✓	10 uni.	-	-
8528	550 cm	120 cm	26.120 l.	4 m³/h	171 kg	✓	12 uni.	-	-
8529	640 cm	120 cm	35.370 l.	7 m³/h	238 kg	✓	14 uni.	-	-



Filtro 4 m³/h
250 W
1/4 hp



Filtro 7 m³/h
400 W
1/2 hp



Escalera de
8 peldaños

8520	350 cm	90 cm	8.150 l.	2 m³/h	49 kg	✓	✓
8521	400 cm	90 cm	10.670 l.	2 m³/h	55 kg	✓	✓
8522	450 cm	90 cm	13.500 l.	2 m³/h	61 kg	✓	✓



Filtro 2 m³/h



Escalera
galvanizada

SERIE
MURO

Piscinas de banda de acero lacado, cubiertas por una funda decorativa de polietileno de alta densidad y calidad fotográfica.

Painted steel pools, covered with a decorative band HDPE and photographic quality.

Piscines en acier laquées, couvertes par une bande décorative PEHD et avec qualité photographique.

OVALADA

MOD. 8538



CIRCULAR

MOD. 8528













PROMO

MOD. 8521



PATENTADO
Decoh!pool
PATENTED

SERIE ROCALLA

										
8346	550X366	120 cm	19.500 l.	4 m ³ /h	177 kg	-	✓	2+10	-	-
8347	640X366	120 cm	25.000 l.	4 m ³ /h	212 kg	-	✓	4+10	-	-
8348	730X366	120 cm	28.500 l.	4 m ³ /h	238 kg	✓	-	6+10	-	-
8349	915X457	120 cm	45.000 l.	7 m ³ /h	312 kg	✓	-	6+10	-	-
8350	915X457	120 cm	45.000 l.	8 m ³ /h	320 kg	✓	-	6+10	-	-



Filtro 4 m³/h
250 W
1/4 hp



Filtro 7 m³/h
400 W
1/2 hp











Filtro 8 m³/h
450 W
3/4 hp



Escalera de
8 peldaños



Escalera de
plataforma

									
8343	350 cm	120 cm	10.580 l.	4 m ³ /h	129 kg	✓	10 uni.	-	-
8344	460 cm	120 cm	18.000 l.	4 m ³ /h	150 kg	✓	10 uni.	-	-
8345	550 cm	120 cm	26.120 l.	4 m ³ /h	171 kg	✓	12 uni.	-	-
8342	640 cm	120 cm	35.370 l.	7 m ³ /h	238 kg	✓	14 uni.	-	-









Filtro 4 m³/h
250 W
1/4 hp



Filtro 7 m³/h
400 W
1/2 hp



Escalera de
8 peldaños

							
8610	350 cm	90 cm	8.150 l.	2 m ³ /h	49 kg	✓	✓
8611	400 cm	90 cm	10.670 l.	2 m ³ /h	55 kg	✓	✓
8612	450 cm	90 cm	13.500 l.	2 m ³ /h	61 kg	✓	✓



Filtro 2 m³/h



Escalera
galvanizada

SERIE
ROCALLA

Piscinas de banda de acero lacado, cubiertas por una funda decorativa de polietileno de alta densidad y calidad fotográfica.

Painted steel pools, covered with a decorative band HDPE and photographic quality.

Piscines en acier laquées, couvertes par une bande décorative PEHD et avec qualité photographique.

OVALADA

MCD. 8348



CIRCULAR

MCD. 8345



PROMO

MCD. 8611



PATENTADO
Decoh!pool
PATENTED



SERIE PIEDRA GRIS

8130	550X366	120 cm	19.500 l.	4 m³/h	177 kg	-	✓	2+10	-	-
8131	640X366	120 cm	25.000 l.	4 m³/h	212 kg	-	✓	4+10	-	-
8132	730X366	120 cm	28.500 l.	4 m³/h	238 kg	✓	-	6+10	-	-
8133	915X457	120 cm	45.000 l.	7 m³/h	312 kg	✓	-	6+10	-	-
8134	915X457	120 cm	45.000 l.	8 m³/h	320 kg	✓	-	6+10	-	-



Filtro 4 m³/h
250 W
1/4 hp

Filtro 7 m³/h
400 W
1/2 hp

Filtro 8 m³/h
450 W
3/4 hp

Escalera de
8 peldaños

Escalera de
plataforma

6208	350 cm	120 cm	10.580 l.	4 m³/h	129 kg	✓	10 uni.	-	-
6223	460 cm	120 cm	18.000 l.	4 m³/h	150 kg	✓	10 uni.	-	-
6235	550 cm	120 cm	26.120 l.	4 m³/h	171 kg	✓	12 uni.	-	-
8135	640 cm	120 cm	35.370 l.	7 m³/h	238 kg	✓	14 uni.	-	-



Filtro 4 m³/h
250 W
1/4 hp

Filtro 7 m³/h
400 W
1/2 hp

Escalera de
8 peldaños

8138	350 cm	90 cm	8.150 l.	2 m³/h	49 kg	✓	✓
8139	400 cm	90 cm	10.670 l.	2 m³/h	55 kg	✓	✓
8140	450 cm	90 cm	13.500 l.	2 m³/h	61 kg	✓	✓



Filtro 2 m³/h

Escalera
galvanizada

SERIE
PIEDRA GRIS

Piscinas de banda de acero lacado, cubiertas por una funda decorativa de polietileno de alta densidad y calidad fotográfica.

Painted steel pools, covered with a decorative band HDPE and photographic quality.

Piscines en acier laquées, couvertes par une bande décorative PEHD et avec qualité photographique.

OVALADA

MOD. 8132



CIRCULAR

MOD. 6235













PROMO

MOD. 8139



PATENTADO
Decoh!pool
PATENTED

SERIE MOSAICO

										
8153	550X366	120 cm	19.500 l.	4 m³/h	177 kg	-	✓	2+10	-	-
8154	640X366	120 cm	25.000 l.	4 m³/h	212 kg	-	✓	4+10	-	-
8155	730X366	120 cm	28.500 l.	4 m³/h	238 kg	✓	-	6+10	-	-
8156	915X457	120 cm	45.000 l.	7 m³/h	312 kg	✓	-	6+10	-	-
8157	915X457	120 cm	45.000 l.	8 m³/h	320 kg	✓	-	6+10	-	-



Filtro 4 m³/h
250 W
1/4 hp



Filtro 7 m³/h
400 W
1/2 hp











Filtro 8 m³/h
450 W
3/4 hp



Escalera de
8 peldaños



Escalera de
plataforma

									
8145	350 cm	120 cm	10.580 l.	4 m³/h	129 kg	✓	10 uni.	-	-
8146	460 cm	120 cm	18.000 l.	4 m³/h	150 kg	✓	10 uni.	-	-
8147	550 cm	120 cm	26.120 l.	4 m³/h	171 kg	✓	12 uni.	-	-
8148	640 cm	120 cm	35.370 l.	7 m³/h	238 kg	✓	14 uni.	-	-









Filtro 4 m³/h
250 W
1/4 hp



Filtro 7 m³/h
400 W
1/2 hp



Escalera de
8 peldaños

							
8150	350 cm	90 cm	8.150 l.	2 m³/h	49 kg	✓	✓
8151	400 cm	90 cm	10.670 l.	2 m³/h	55 kg	✓	✓
8152	450 cm	90 cm	13.500 l.	2 m³/h	61 kg	✓	✓



Filtro 2 m³/h



Escalera
galvanizada

SERIE
MOSAICO

Piscinas de banda de acero lacado, cubiertas por una funda decorativa de polietileno de alta densidad y calidad fotográfica.

Painted steel pools, covered with a decorative band HDPE and photographic quality.

Piscines en acier laquées, couvertes par une bande décorative PEHD et avec qualité photographique.

OVALADA

MOD. 8155



CIRCULAR

MOD. 8147













PROMO

MOD. 8151



PATENTADO
Decoh!pool
PATENTED

SERIE TRENCADIS

										
8580	550X366	120 cm	19.500 l.	4 m³/h	177 kg	-	✓	2+10	-	-
8581	640X366	120 cm	25.000 l.	4 m³/h	212 kg	-	✓	4+10	-	-
8582	730X366	120 cm	28.500 l.	4 m³/h	238 kg	✓	-	6+10	-	-
8583	915X457	120 cm	45.000 l.	7 m³/h	312 kg	✓	-	6+10	-	-
8584	915X457	120 cm	45.000 l.	8 m³/h	320 kg	✓	-	6+10	-	-



Filtro 4 m³/h
250 W
1/4 hp



Filtro 7 m³/h
400 W
1/2 hp











Filtro 8 m³/h
450 W
3/4 hp



Escalera de
8 peldaños



Escalera de
plataforma

									
8585	350 cm	120 cm	10.580 l.	4 m³/h	129 kg	✓	10 uni.	-	-
8586	460 cm	120 cm	18.000 l.	4 m³/h	150 kg	✓	10 uni.	-	-
8587	550 cm	120 cm	26.120 l.	4 m³/h	171 kg	✓	12 uni.	-	-
8591	640 cm	120 cm	35.370 l.	7 m³/h	238 kg	✓	14 uni.	-	-









Filtro 4 m³/h
250 W
1/4 hp



Filtro 7 m³/h
400 W
1/2 hp



Escalera de
8 peldaños

							
8588	350 cm	90 cm	8.150 l.	2 m³/h	49 kg	✓	✓
8589	400 cm	90 cm	10.670 l.	2 m³/h	55 kg	✓	✓
8590	450 cm	90 cm	13.500 l.	2 m³/h	61 kg	✓	✓



Filtro 2 m³/h



Escalera
galvanizada

SERIE
TRENCADIS

Piscinas de banda de acero lacado, cubiertas por una funda decorativa de polietileno de alta densidad y calidad fotográfica.

Painted steel pools, covered with a decorative band HDPE and photographic quality.

Piscines en acier laquées, couvertes par une bande décorative PEHD et avec qualité photographique.

OVALADA

MOD. 8582



CIRCULAR

MOD. 8587



PROMO

MOD. 8589



PATENTADO
Decoh!pool
PATENTED

SERIE OCEANO

8566	550X366	120 cm	19.500 l.	4 m³/h	177 kg	-	✓	2+10	-	-
8567	640X366	120 cm	25.000 l.	4 m³/h	212 kg	-	✓	4+10	-	-
8568	730X366	120 cm	28.500 l.	4 m³/h	238 kg	✓	-	6+10	-	-
8569	915X457	120 cm	45.000 l.	7 m³/h	312 kg	✓	-	6+10	-	-
8570	915X457	120 cm	45.000 l.	8 m³/h	320 kg	✓	-	6+10	-	-



Filtro 4 m³/h
250 W
1/4 hp



Filtro 7 m³/h
400 W
1/2 hp



Filtro 8 m³/h
450 W
3/4 hp



Escalera de
8 peldaños



Escalera de
plataforma

8556	350 cm	120 cm	10.580 l.	4 m³/h	129 kg	✓	10 uni.	-	-
8557	460 cm	120 cm	18.000 l.	4 m³/h	150 kg	✓	10 uni.	-	-
8558	550 cm	120 cm	26.120 l.	4 m³/h	171 kg	✓	12 uni.	-	-
8559	640 cm	120 cm	35.370 l.	7 m³/h	238 kg	✓	14 uni.	-	-



Filtro 4 m³/h
250 W
1/4 hp



Filtro 7 m³/h
400 W
1/2 hp



Escalera de
8 peldaños

8550	350 cm	90 cm	8.150 l.	2 m³/h	49 kg	✓	✓
8551	400 cm	90 cm	10.670 l.	2 m³/h	55 kg	✓	✓
8552	450 cm	90 cm	13.500 l.	2 m³/h	61 kg	✓	✓



Filtro 2 m³/h



Escalera
galvanizada

SERIE
OCEANO

Piscinas de banda de acero lacado, cubiertas por una funda decorativa de polietileno de alta densidad y calidad fotográfica.

Painted steel pools, covered with a decorative band HDPE and photographic quality.

Piscines en acier laquées, couvertes par une bande décorative PEHD et avec qualité photographique.

OVALADA

MOD. 8398



CIRCULAR

MOD. 8395



PROMO

MOD. 8602



PATENTADO
Decoh!pool
PATENTED









SERIE MAGNUM CIRCULAR 132 cm



Piscina modelo MAGNUM 132, de 132 cm de altura banda de acero lacado y liner overlap. Modelo con filtro de arena de 6 m³/h.

Pool MAGNUM model 132, 132 cm tall and lacquered steel band overlap liner. Sand filter model of 6 m³ / h.

Piscine MAGNUM modèle 132, 132 cm de hauteur et bande en acier laqué chevauchement iner. Modèle de filtre à sable de 6 m³ / h.

									
8801	350 cm	132 cm	11.500 l.	7 m ³ /h	150 kg	✓	10 uni.	-	-
8802	460 cm	132 cm	20.000 l.	7 m ³ /h	180 kg	✓	10 uni.	-	-
8803	550 cm	132 cm	29.000 l.	7 m ³ /h	235 kg	✓	12 uni.	-	--
8491	350 cm	132 cm	11.500 l.	7 m ³ /h	153 kg	✓	10 uni.	✓	✓
8492	460 cm	132 cm	20.000 l.	7 m ³ /h	185 kg	✓	10 uni.	✓	✓
8493	550 cm	132 cm	29.000 l.	7 m ³ /h	241 kg	✓	12 uni.	✓	✓



Filtro 7 m³/h
400 W
1/2 hp



Escalera de plataforma



Kit de verano:
Cubierta isotérmica.
Termómetro.
Kit de ph.
Recoge hojas.
Dosificador de cloro.



Tapiz

SERIE

MAGNUM OVALADA 132 cm

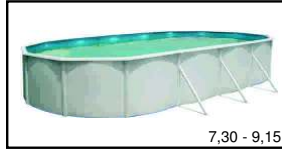

Piscina modelo MAGNUM 132, de 132 cm de altura banda de acero lacado y liner overlap, dependiendo de la longitud de la piscina puede tener más o menos contrafuertes. Modelo con filtro de arena de 6 y 8 m³/h.

Pool MAGNUM model 132, 132 cm tall and lacquered steel band overlap liner, depending on the length of the pool may have more or less buttresses. Sand filter Model 6 and 8 m³ / h.

Piscine MAGNUM modèle 132, 132 cm de hauteur et bande en acier laqué chevauchement liner, en fonction de la longueur de la piscine peut avoir plus ou moins contreforts. Filtre à sable Modèle 6 et 8 m³ / h.

8804	550X366	132 cm	21.500 l.	7 m ³ /h	205 kg	✓	10 uni.	2	-	-	-
8805	640X366	132 cm	27.500 l.	7 m ³ /h	240 kg	✓	10 uni.	4	-	-	-
8806	730X366	132 cm	31.500 l.	8 m ³ /h	337 kg	✓	10 uni.	6	-	-	-
8807	915X457	132 cm	49.500 l.	8 m ³ /h	350 kg	✓	10 uni.	6	-	-	-
8496	550X366	132 cm	21.500 l.	7 m ³ /h	210 kg	✓	10 uni.	2	✓	✓	✓
8497	640X366	132 cm	27.500 l.	7 m ³ /h	245 kg	✓	10 uni.	4	✓	✓	✓
8498	730X366	132 cm	31.500 l.	8 m ³ /h	343 kg	✓	10 uni.	6	✓	✓	✓
8499	915X457	132 cm	49.500 l.	8 m ³ /h	360 kg	✓	10 uni.	6	✓	✓	✓



Filtro 7 m³/h
400 W
1/2 hp



Filtro 8 m³/h
450 W
3/4 hp



Escalera de plataforma



Kit de verano:
Cubierta isotérmica.
Termómetro.
Kit de ph.
Recoge hojas.
Dosificador de cloro.



Tapiz

SERIE

SILVER OVALADA



SILVER OVALADA BLANCO

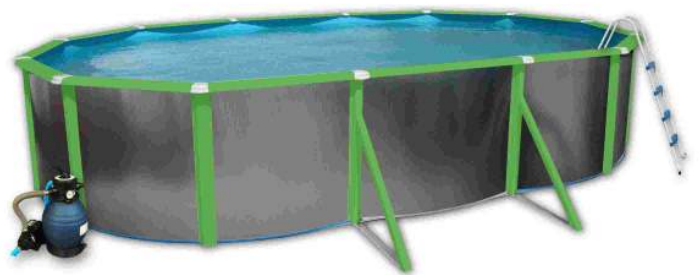

SILVER OVALADA VERDE

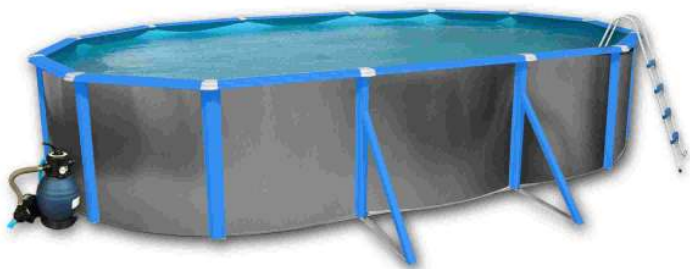

SILVER OVALADA AZUL



SILVER OVALADA FUCSIA

Piscina modelo OVALADA, de 120 cm de alto. Banda de acero galvanizado y perfiles de color, liner overlap, dependiendo de la longitud de la piscina puede tener más o menos contrafuertes.

OVAL pool model, 120 cm high. Galvanized steel band and color profile, liner overlap, depending on the length of the pool may have more or less buttresses.

Modèle de piscine ovale, de 120 cm de haut. Bande en acier galvanisé et les profils de couleurs, le chevauchement de ligne, en fonction de la longueur de la piscine peut avoir plus ou moins contreforts.

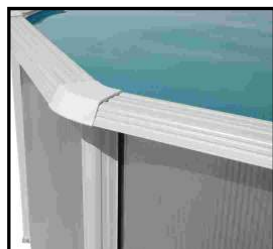

BLANCO

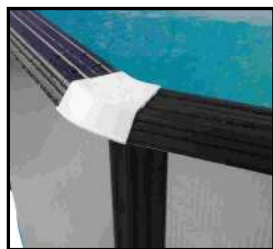

NEGRO

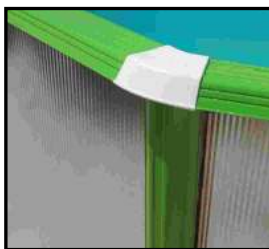

VERDE

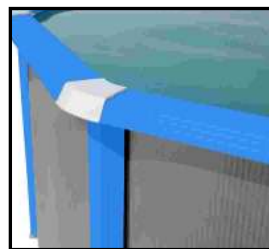

AZUL

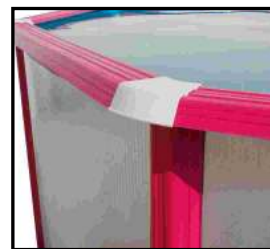

FUCSIA

	8200	550X366	120 cm	19.500 l.	4 m ³ /h	175 kg	✓	-	10 uni.	2
	8201	640X366	120 cm	25.000 l.	4 m ³ /h	210 kg	✓	-	10 uni.	4
	8202	730X366	120 cm	28.500 l.	4 m ³ /h	270 kg	-	✓	10 uni.	6
	8203	915X457	120 cm	45.000 l.	7 m ³ /h	334 kg	-	✓	10 uni.	6
	8204	550X366	120 cm	19.500 l.	4 m ³ /h	175 kg	✓	-	10 uni.	2
	8205	640X366	120 cm	25.000 l.	4 m ³ /h	210 kg	✓	-	10 uni.	4
	8206	730X366	120 cm	28.500 l.	4 m ³ /h	270 kg	-	✓	10 uni.	6
	8207	915X457	120 cm	45.000 l.	7 m ³ /h	334 kg	-	✓	10 uni.	6
	8208	550X366	120 cm	19.500 l.	4 m ³ /h	175 kg	✓	-	10 uni.	2
	8209	640X366	120 cm	25.000 l.	4 m ³ /h	210 kg	✓	-	10 uni.	4
	8210	730X366	120 cm	28.500 l.	4 m ³ /h	270 kg	-	✓	10 uni.	6
	8211	915X457	120 cm	45.000 l.	7 m ³ /h	334 kg	-	✓	10 uni.	6
	8212	550X366	120 cm	19.500 l.	4 m ³ /h	175 kg	✓	-	10 uni.	2
	8213	640X366	120 cm	25.000 l.	4 m ³ /h	210 kg	✓	-	10 uni.	4
	8214	730X366	120 cm	28.500 l.	4 m ³ /h	270 kg	-	✓	10 uni.	6
	8215	915X457	120 cm	45.000 l.	7 m ³ /h	334 kg	-	✓	10 uni.	6
	8216	550X366	120 cm	19.500 l.	4 m ³ /h	175 kg	✓	-	10 uni.	2
	8217	640X366	120 cm	25.000 l.	4 m ³ /h	210 kg	✓	-	10 uni.	4
	8218	730X366	120 cm	28.500 l.	4 m ³ /h	270 kg	-	✓	10 uni.	6
	8219	915X457	120 cm	45.000 l.	7 m ³ /h	334 kg	-	✓	10 uni.	6



Filtro 4 m³/h
250 W
1/4 hp



Filtro 7 m³/h
400 W
1/2 hp



Escalera de 8 peldaños



Escalera de plataforma

SERIE

SILVER CANARIAS



CIRCULAR

MOD.8213



SILVER CANARIAS NEGRO

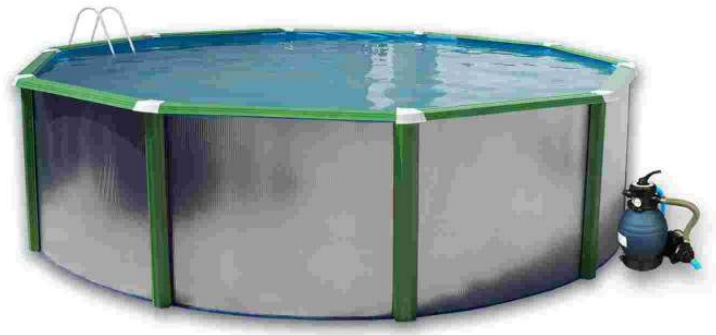

SILVER CANARIAS VERDE



SILVER CANARIAS BLANCO











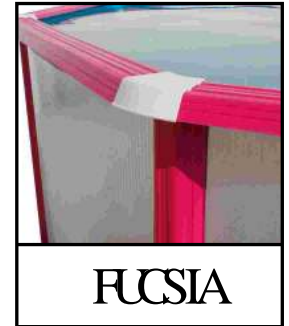
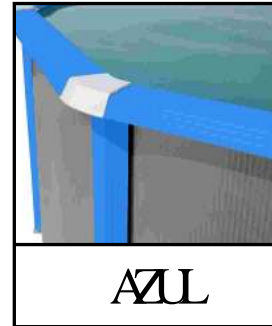
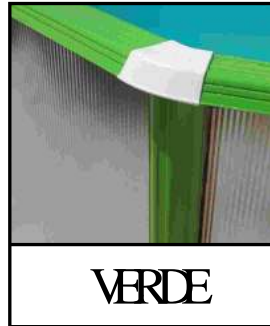



SILVER CANARIAS FUCSIA

Piscina modelo CANARIAS, son piscinas circulares con columnas de 120 cm de altura. Banda de acero galvanizado y perfiles de color, liner overlap.

CANARY pool model are circular colonnaded pools of 120 cm in height. Galvanized steel band and color profile, liner overlap.

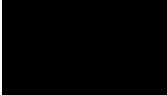
Modèle de piscine CANARY sont circulaires piscines colonnades de 120 cm de hauteur. Bande en acier galvanisé et les profils de couleurs, le chevauchement de ligne.



								
	8220	350 cm	120 cm	10.580 l.	4 m³/h	128 kg	✓	10 uni.
	8221	460 cm	120 cm	18.000 l.	4 m³/h	148 kg	✓	10 uni.
	8222	550 cm	120 cm	26.120 l.	4 m³/h	168 kg	✓	12 uni.
	8224	350 cm	120 cm	10.580 l.	4 m³/h	128 kg	✓	10 uni.
	8225	460 cm	120 cm	18.000 l.	4 m³/h	148 kg	✓	10 uni.
	8226	550 cm	120 cm	26.120 l.	4 m³/h	168 kg	✓	12 uni.
	8228	350 cm	120 cm	10.580 l.	4 m³/h	128 kg	✓	10 uni.
	8229	460 cm	120 cm	18.000 l.	4 m³/h	148 kg	✓	10 uni.
	8230	550 cm	120 cm	26.120 l.	4 m³/h	168 kg	✓	12 uni.
	8232	350 cm	120 cm	10.580 l.	4 m³/h	128 kg	✓	10 uni.
	8233	460 cm	120 cm	18.000 l.	4 m³/h	148 kg	✓	10 uni.
	8234	550 cm	120 cm	26.120 l.	4 m³/h	168 kg	✓	12 uni.
	8236	350 cm	120 cm	10.580 l.	4 m³/h	128 kg	✓	10 uni.
	8237	460 cm	120 cm	18.000 l.	4 m³/h	148 kg	✓	10 uni.
	8238	550 cm	120 cm	26.120 l.	4 m³/h	168 kg	✓	12 uni.



Filtro 4 m³/h
250 W
1/4 hp



Escalera de 8 peldaños

SERIE OVALADA



5.50



6.40

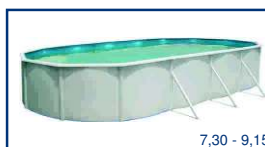

7.30 - 9.15



12



OVALADA

MOD. 8930

Piscina modelo OVALADA, de 120 cm de alto y hasta 12 metros de largo. Banda de acero lacado y liner overlap, dependiendo de la longitud de la piscina puede tener más o menos contrafuertes.

OVAL pool model, 120 cm high and 12 meters long. Lacquered steel band and liner overlap, depending on the length of the pool may have more or less buttresses.

Modèle de piscine ovale, de 120 cm de haut et 12 mètres de long. Bande en acier laqué et le chevauchement de ligne, en fonction de la longueur de la piscine peut avoir plus ou moins contreforts.

8933	550X366	120 cm	19.500 l.	4 m ³ /h	175 kg	-	✓	10 uni.	2	-	-
8934	640X366	120 cm	25.000 l.	4 m ³ /h	210 kg	-	✓	10 uni.	4	-	-
8930	730X366	120 cm	28.500 l.	4 m ³ /h	270 kg	✓	-	10 uni.	6	-	-
8931	915X457	120 cm	45.000 l.	7 m ³ /h	334 kg	✓	-	10 uni.	6	-	-
8932	915X457	120 cm	45.000 l.	8 m ³ /h	362 kg	✓	-	10 uni.	6	-	-
8935	1200X457	120 cm	55.000 l.	10 m ³ /h	466 kg	✓	-	10 uni.	10	-	-
8936	1200X457	120 cm	55.000 l.	15 m ³ /h	546 kg	✓	-	10 uni.	10	-	-
8475	550X366	120 cm	19.500 l.	4 m ³ /h	180 kg	-	✓	10 uni.	2	✓	✓
8476	640X366	120 cm	25.000 l.	4 m ³ /h	215 kg	-	✓	10 uni.	4	✓	✓
8477	730X366	120 cm	28.500 l.	4 m ³ /h	278 kg	✓	-	10 uni.	6	✓	✓
8478	915X457	120 cm	45.000 l.	7 m ³ /h	319 kg	✓	-	10 uni.	6	✓	✓
8474	915X457	120 cm	45.000 l.	8 m ³ /h	355 kg	✓	-	10 uni.	6	✓	✓
8479	1200X457	120 cm	55.000 l.	10 m ³ /h	412 kg	✓	-	10 uni.	10	✓	✓
8490	1200X457	120 cm	55.000 l.	15 m ³ /h	442 kg	✓	-	10 uni.	10	✓	✓

Filtro 4 m ³ /h 250 W 1/4 hp	Filtro 7 m ³ /h 400 W 1/2 hp	Filtro 8 m ³ /h 450 W 3/4 hp	Filtro 10 m ³ /h 600 W 1 hp	Filtro 15 m ³ /h 1.000 W 1,3 hp	Escalera de 8 peldaños	Escalera de plataforma	Kit de verano: Cubierta isotérmica. Termómetro. Kit de ph. Recoge hojas. Dosificador de cloro.	Tapiz

SERIE CANARIAS



CIRCULAR

MOD.8886

Piscina modelo CANARIAS, son piscinas circulares con columnas de 120 cm de altura y hasta 6,4 metros de diámetro interior. Banda de acero lacado y liner overlap.

CANARY pool model are circular colonnaded pools of 120 cm in height and up to 6.4 m internal diameter. Lacquered steel strip and overlap liner.

Modèle de piscine CANARY sont circulaires piscines colonnades de 120 cm de hauteur et jusqu'à 6,4 m de diamètre intérieur. Bande d'acier laqué et revêtement de chevauchement.

8889	230 cm	120 cm	4.570 l.	-	2 m ³ /h	77 kg	✓	10 uni.	-	-
6013	350 cm	120 cm	10.580 l.	4 m ³ /h	-	128 kg	✓	10 uni.	-	-
8885	460 cm	120 cm	18.000 l.	4 m ³ /h	-	148 kg	✓	10 uni.	-	-
8886	550 cm	120 cm	26.120 l.	4 m ³ /h	-	168 kg	✓	12 uni.	-	-
8887	640 cm	120 cm	35.370 l.	7 m ³ /h	-	235 kg	✓	14 uni.	-	-
8485	230 cm	120 cm	4.570 l.	-	2 m ³ /h	79 kg	✓	10 uni.	✓	✓
8480	350 cm	120 cm	10.580 l.	4 m ³ /h	-	134 kg	✓	10 uni.	✓	✓
8481	460 cm	120 cm	18.000 l.	4 m ³ /h	-	153 kg	✓	10 uni.	✓	✓
8482	550 cm	120 cm	26.120 l.	4 m ³ /h	-	174 kg	✓	12 uni.	✓	✓
8486	640 cm	120 cm	35.370 l.	7 m ³ /h	-	243 kg	✓	14 uni.	✓	✓



Filtro de cartucho
2 m³/h



Filtro 4 m³/h
250 W
1/4 hp



Filtro 7 m³/h
400 W
1/2 hp



Escalera de 8 peldaños



Kit de verano:
Cubierta isotérmica.
Termómetro.
Kit de ph.
Recoge hojas.
Dosificador de cloro.



Tapiz

SERIE

SILVERLUNA



OVALADA

MOD.8242

Piscina modelo SYLVER LUNA, piscina con columnas de 120 cm de altura. Banda de acero galvanizado y perfiles de color, liner overlap. Incorporan un skimmer filtrante de 3.600 l/h - 93W.

SYLVER LUNA model pool, pool with columns 120 cm high. Galvanized steel band and color profile, liner overlap. They incorporate a skimmer filter 3.600 l/h - 93W.

Piscine modèle SYLVER, une piscine avec des colonnes 120 cm de haut. Bande en acier galvanisé et les profils de couleurs. Ils intègrent une écumeuse filtre 3.600 l/h - 93W.



SILVERLUNA NEGRO



SILVERLUNA VERDE



SILVERLUNA FUCSIA



SILVERLUNA AZUL

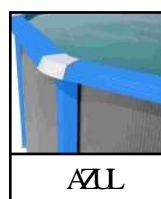
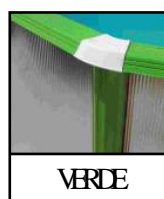

8242	550X366	120 cm	19.500 l.	3,6 m ³ /h	175 kg	✓	10 uni.	2	
8245	550X366	120 cm	19.500 l.	3,6 m ³ /h	175 kg	✓	10 uni.	2	
8248	550X366	120 cm	19.500 l.	3,6 m ³ /h	175 kg	✓	10 uni.	2	
8251	550X366	120 cm	19.500 l.	3,6 m ³ /h	175 kg	✓	10 uni.	2	
8254	550X366	120 cm	19.500 l.	3,6 m ³ /h	175 kg	✓	10 uni.	2	



Skimmer filtrante
3,6 m³/h
93W



Escalera de
8 peldaños

SERIE

SILVERLUNA



CIRCULAR

MOD. 8252



SILVERLUNA NEGRO

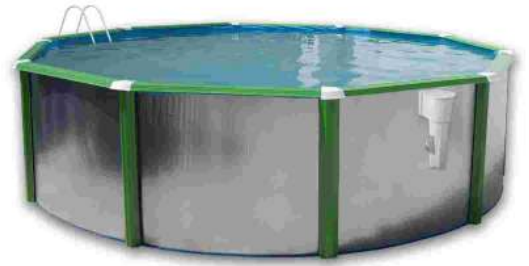

SILVERLUNA VERDE



SILVERLUNA BLANCO



SILVERLUNA AZUL



BLANCO



NEGRO

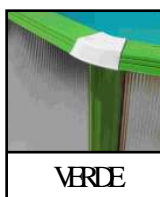

VERDE

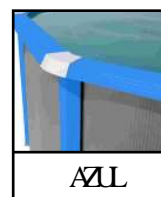

AZUL



FUCSIA



	8240	350 cm	120 cm	10.580 l.	3,6 m ³ /h	128 kg	✓	10 uni.
	8241	460 cm	120 cm	18.000 l.	3,6 m ³ /h	148 kg	✓	10 uni.
	8243	350 cm	120 cm	10.580 l.	3,6 m ³ /h	128 kg	✓	10 uni.
	8244	460 cm	120 cm	18.000 l.	3,6 m ³ /h	148 kg	✓	10 uni.
	8246	350 cm	120 cm	10.580 l.	3,6 m ³ /h	128 kg	✓	10 uni.
	8247	460 cm	120 cm	18.000 l.	3,6 m ³ /h	148 kg	✓	10 uni.
	8249	350 cm	120 cm	10.580 l.	3,6 m ³ /h	128 kg	✓	10 uni.
	8250	460 cm	120 cm	18.000 l.	3,6 m ³ /h	148 kg	✓	10 uni.
	8252	350 cm	120 cm	10.580 l.	3,6 m ³ /h	128 kg	✓	10 uni.
	8253	460 cm	120 cm	18.000 l.	3,6 m ³ /h	148 kg	✓	10 uni.



Skimmer filtrante
3,6 m³/h
93W



Escalera de
8 peldaños

SERIE
LUNA

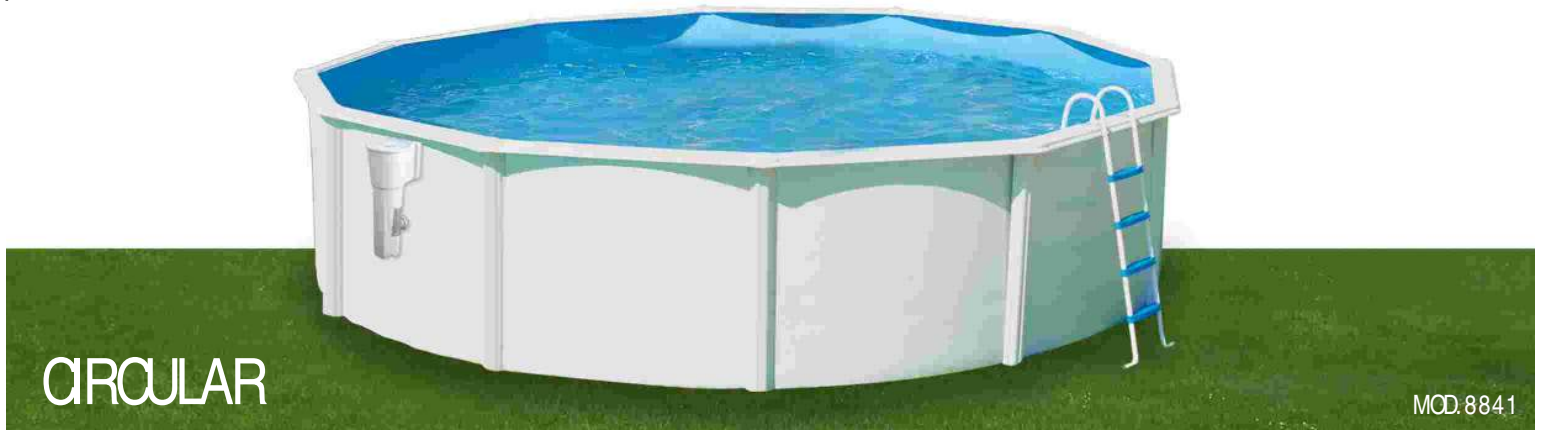

Piscina modelo LUNA, piscina con columnas de 120 cm de altura. Banda de acero lacado y liner overlap. Incorporan un skimmer filtrante de 3.600 l/h - 93W.

LUNA model pool, pool with columns 120 cm high. Lacquered steel strip and overlap liner. They incorporate a skimmer filter 3.600 l/h - 93W.

Piscine modèle LUNA, une piscine avec des colonnes 120 cm de haut. Bande d'acier laqué et revêtement de chevauchement. Ils intègrent une écumoire filtre 3.600 l/h - 93W

8840	350 cm	120 cm	10.580 l.	3,6 m³/h	128 kg	✓	10 uni.	-	
8841	460 cm	120 cm	18.000 l.	3,6 m³/h	148 kg	✓	10 uni.	-	
8844	550X366	120 cm	19.500 l.	3,6 m³/h	175 kg	✓	10 uni.	2	



Skimmer filtrante
3,6 m³/h
93W

Escalera de 8 peldaños



Piscina modelo PROMO, son piscinas circulares de 90 cm de altura y de hasta 4,5 metros de diámetro. Banda de acero lacado y liner overlap con perfiles de plástico.

PROMO pool model are circular pools of 90 cm in height and 4.5 meters in diameter. Steel band overlap liner lacquering and plastic profiles..

Modèle de piscine PROMO ya des piscines circulaires de 90 cm de hauteur et 4,5 mètres de diamètre. Bracelet en acier se chevauchent laquage doublure et profilés en plastique.

8862	350 cm	90 cm	8.150 l.	2 m³/h	50 kg	✓	✓
8863	400 cm	90 cm	10.670 l.	2 m³/h	57 kg	✓	✓
8864	450 cm	90 cm	13.500 l.	2 m³/h	62 kg	✓	✓



Filtro de cartucho
2 m³/h



Escalera de 4 peldaños



Perfiles de plástico

PISCINAS TUBULARES

Las piscinas Tubulares enfocadas a un público infantil destacan por su fácil instalación, la principal característica que las diferencia del resto es el diseño de sus cantoneras en polipropileno inyectado, el cual le confiere unas propiedades físicas y estéticas difíciles de alcanzar con otros sistemas.

Les piscines tubulaires destinées au public infantile sont très faciles à installer. La principale caractéristique qui la différencie d'autres piscines similaires est la conception de ses pièces d'union (cornières) en polypropylène injecté et dont les propriétés physiques et esthétiques sont difficilement retrouvables dans l'autres systèmes.

The steel frame swimming pools for children use are very easy to install. The principal characteristic which differentiates these swimming pools from other similar, is the design of its elbow joints made out of injected polypropylene. Its physical and aesthetic properties are not easily found in other systems.

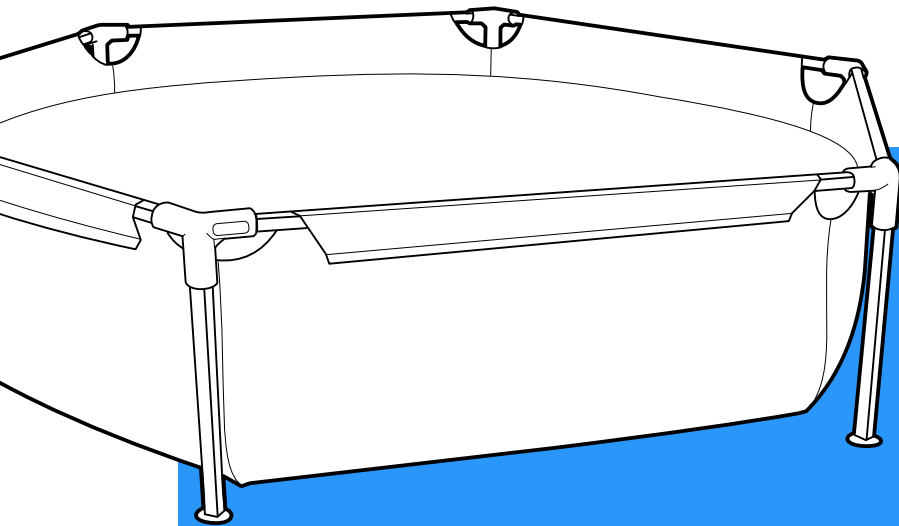

P.V.C. POOLS

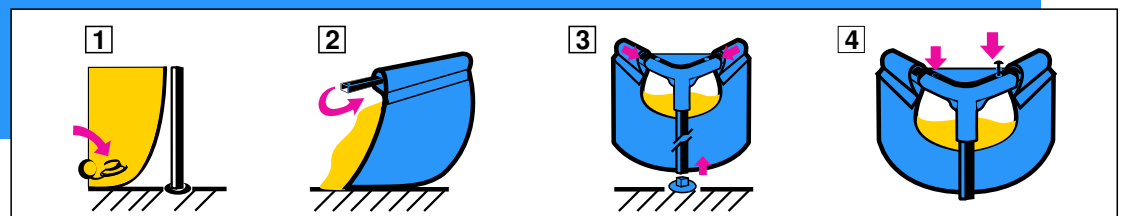

PISCINA DESMONTABLE DE ESTRUCTURA TUBULAR

LINER: Soldadura especial por alta frecuencia, realizada en el sentido correcto de las tensiones que se producen por el peso y el movimiento del agua.

Desagüe con acoplamiento para manguera.

ESTRUCTURA: Acero especial con tratamiento anticorrosivo, recubierta con epoxi no tóxico.

Cantoneras inyectadas para impedir su oxidación y obtener una mayor flexibilidad y resistencia, evitando así los problemas usuales de las uniones metálicas soldadas que no ceden por carecer de la mínima flexibilidad necesaria.



KIT PISCINE DÉMONTABLE TUBULAIRE

LINER: Soudure spéciale à haute fréquence, suivant le sens des tensions produites par le poids et le mouvement de l'eau. Sortie d'eau dotée d'accouplement pour tuyau.

STRUCTURE: Acier spécial traité contre la corrosion et recouverte d'époxy non-toxique.

Cornières injectées pour éviter une oxydation et obtenir une flexibilité et une résistance majeure, le manque de flexibilité étant le problème courant des joints métalliques soudés.



KIT PORTABLE STEEL FRAME SWIMMINGPOOL

LINER: Special high frequency welding, taking into account the sense of the tensions that are caused by the weight and movement of the water. Drainage system with hose adaptor.

STEELFRAME: Special steel frame, corrosion resistant, covered with a nontoxic epoxy.

Injected elbow joints to avoid rusting and provide flexibility and resistance, being the main problem of welded metal elbow joints a lack of flexibility.

SERIE BABY



AZUL



NARANJA



FUCSIA



VERDE

Mod. 3115

					COLOR			
3114	85 cm	4	15 cm	72 l.		✓	✓	5 kg
3115	85 cm	4	15 cm	72 l.		✓	✓	5 kg
3116	85 cm	4	15 cm	72 l.		✓	✓	5 kg
3117	85 cm	4	15 cm	72 l.		✓	✓	5 kg

SERIE BASIC

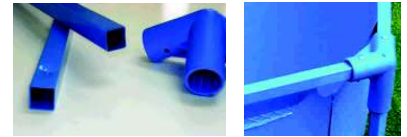

SERIE TOBOGÁN



Mod. 8311



BASICS	3153	120 cm	4	35 cm	425 l.	✓	4,7 kg	-
	3169	190 cm	4	45 cm	1.400 l.	✓	8,7 kg	-
	3164	200 cm	6	50 cm	1.100 l.	✓	7 kg	-
	3170	215 cm	6	45 cm	1.150 l.	✓	7 kg	-
	3155	230 cm	6	50 cm	1.500 l.	✓	9 kg	-
	3165	250 cm	8	50 cm	1.800 l.	✓	10,6 kg	-
	3168	300 cm	8	55 cm	3.300 l.	✓	13,5 kg	-
TOBOGÁN	8301	120 cm	4	35 cm	425 l.	✓	4,7 kg	✓
	8310	215 cm	6	45 cm	1.150 l.	✓	7 kg	✓

ACCESORIOS

ACCESSORIES

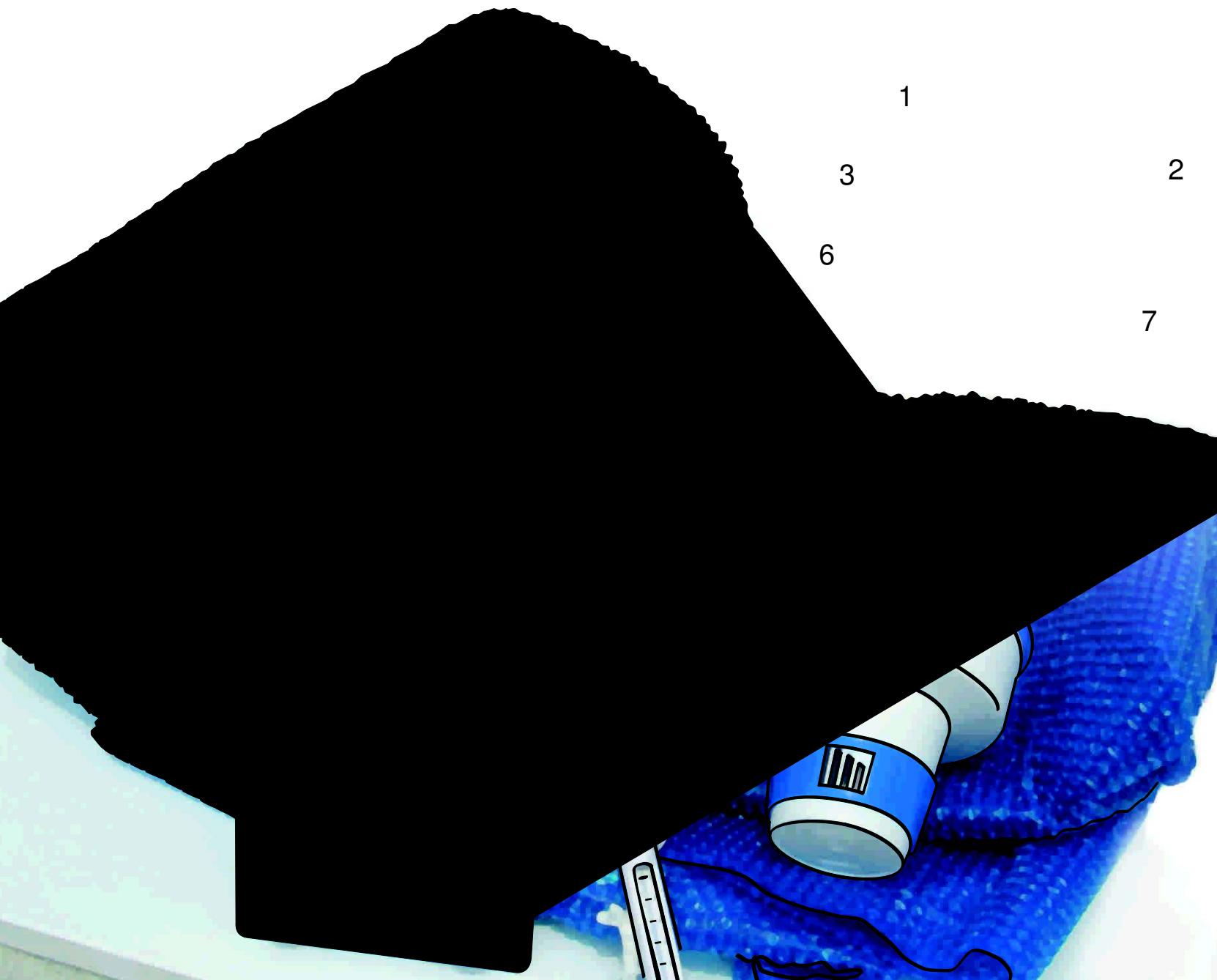
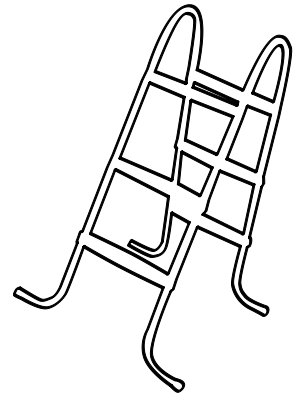

1

3

2

6

7

Cabezal 4 vías - 4 Way selector head - Vanne à 4 voies

<p>WINTER INVIERNO</p>	<p>BACKWASH CONTRALAVADO</p>	<p>RINSE ENJUAGUE</p>	<p>FILTRATION FILTRACION</p>

Cabezal 6 vías - 6 Way selector head - Vanne à 6 voies

<p>WINTER INVIERNO</p>	<p>FILTRATION FILTRACION</p>	<p>BACKWASH CONTRALAVADO</p>	<p>RINSE ENJUAGUE</p>

<p>WASTE DESAGÜE</p>	<p>RECIRCULATE CIRCULACIÓN</p>	<p>CLOSED CERRADO</p>

Medida skimmer
Skimmer measure
Mesurer skimmer

ACCESORIOS
FILTROS

Los filtros de arena se sirven sin mangueras y sin arena. Arena recomendada 0.4-0.8 micras.
Sand filters are supplied without hoses and no sand. Recommended sand 0.4-0.8 microns.
Les filtres à sable sont livrés sans les tuyaux et pas de sable. Sable 0,4-0,8 microns recommandée.



Ref. 4884
Filtro cartucho.
Cartridge filter.
Filtre à cartouche.



Ref. 4799
Skimmer filtrante
Skimmer filter.
Filtre skimmer.



Ref.4885
SF25
Filtro de arena
Sand filter.
Filtre à sable.



Ref.4886
PPF45/7000
Filtro de arena
Sand filter.
Filtre à sable.









Ref.4898
SF65
Filtro de arena
Sand filter.
Filtre à sable.



Ref.4897
SF85
Filtro de arena
Sand filter.
Filtre à sable.



Ref.4892
SF200
Filtro de arena
Sand filter.
Filtre à sable.

Re f.	 m³/h	 hp-W	 cm	 Kg		 Pre- filter
4884	2 m³/h	46W	18 cm	cartucho	-	-
4799	3,6 m³/h	93W	21 cm	cartucho	-	-
4885-SF25	4 m³/h	1/4 - 250	32 cm	18-20	4 vías	-
4886-SF45	7 m³/h	1/2 - 400	39 cm	25-30	4 vías	✓
4898-SF65	8 m³/h	3/4 - 450	47 cm	50-60	6 vías	✓
4897-SF85	10 m³/h	1 - 600	47 cm	75-80	6 vías	✓
4892-SF200	15 m³/h	1,3-1.000	68 cm	150-180	6 vías	✓

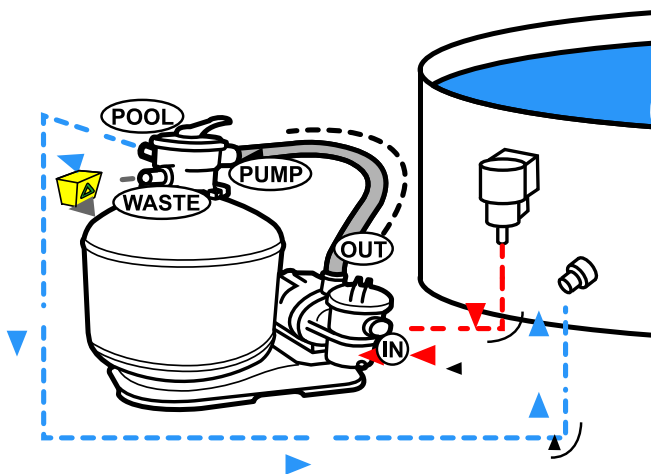

Conexiones de las mangueras.
Connections of the hoses.
Les connexions des tuyaux.

Motores de bobinado eléctrico, testados y probados, garantía de fiabilidad y durabilidad.
 Electric winding engines, tested and proven, guarantee of reliability and durability.
 Moteurs électriques sinuenses, testées et éprouvées, gage de fiabilité et de durabilité.



Ref. 4756
72512
Bomba. Pump. Pompe.



Ref.4757
PP7000
Bomba. Pump. Pompe.



Ref.4758
SP8000
Bomba. Pump. Pompe.







Ref.4759
SP10.000
Bomba. Pump. Pompe.



Ref.4760
SP15.000
Bomba. Pump. Pompe.



Ref. 4761 - 4 vías
Cabezal selector.
Head selector.
Tete selecteur.

Ref.	 m ³ /h	 hp-W	 Pre-filter r	 Ø
4756	4 m ³ /h	1/4 - 250	-	32 mm
4757	7 m ³ /h	1/2 - 400	✓	32 mm
4758	8 m ³ /h	3/4 - 450	✓	38 mm
4759	10 m ³ /h	1 - 600	✓	38 mm
4760	15 m ³ /h	1,3-1.000	✓	38 mm



Ref. 4762 - 6 vías
Cabezal selector.
Head selector.
Tete selecteur.

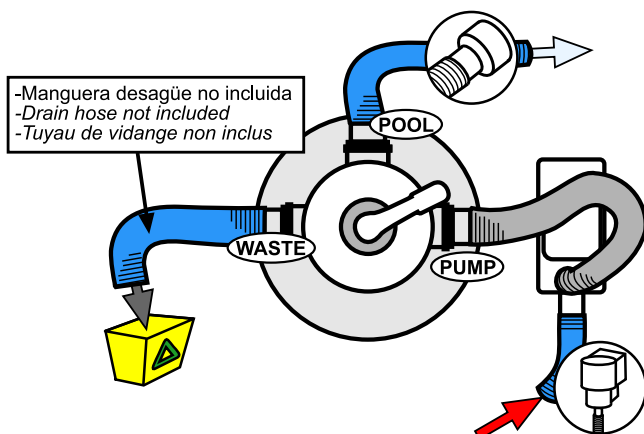

Circuito del agua.
Circuit water.
Circuit d'eau.

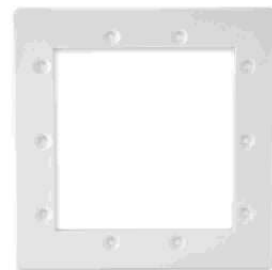

Ref. 4863
Skimmer completo: Cestillo, compuerta, racor, adaptador para barredera.
Dimensiones de boca 14,8 x 14,1 cm.
Full skimmer: Skimmer's basket, floater (door), hose's racor and an adapter to connect the hose.
Skimmer complet: panier, porte, raccord du tuyau et un adaptateur pour connecter le tuyau.

Ref. 9210
Cuerpo skimmer.
Dimensiones de boca 14,8 x 14,1 cm.
Skimmer for hole 14,8 x 14,1 cm.
Skimmer pour le trou 14,8 x 14,1 cm.

Ref. 9202
Marco.
Framework.
Cadre.

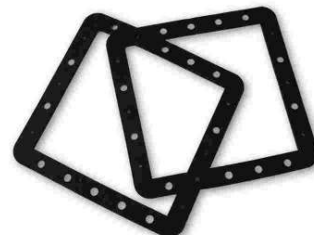

Ref. 4728
Cestillo.
Basquet.
Panier.

Ref. 4733
Adaptador Barredera.
Adapter to connect bottom cleaner.
Adaptateur pour connecter le tuyau du nettoyeur de fonds.

Ref. 4755
Compuerta.
Floating door.
Porte du skimmer.

Ref. 4754
Junta skimmer.
Skimmer's rubber gaskets.
Joints en caoutchouc pour l'écumoire.



Ref. 4734
Válvula de salida.
Valve.
Soupape.

Ref. 4732
Racor skimmer/válvula.
Racor skimmer/valve.
Racor simmer/soupape.

Ref. 4739
Abrazaderas metálicas.
Metal clamps.
Colliers de serrage en metal pour les tuyaux.

Ref. 4743
Tapones.
Plugs.
Bouchons.

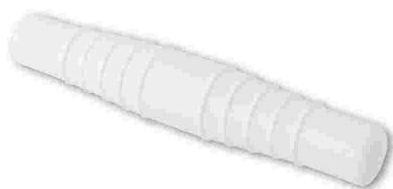

Ref. 4729
Racor Ø32/38 mm.
Fitting Ø32/38 mm.
Essayage Ø32/38 mm.

Ref. 4767
Conector doble Ø32/38 mm.
Double connector Ø32/38 mm.
Double connecteur Ø32/38 mm.

Ref. 4742 - x5
Embellecedor curvo.
Curved hub cap.
Enjoliveur curve.

Ref. 4741 - x2
Embellecedor recto.
Straight hub cap.
Enjoliveur droit.



Depósito. Tank. Dépôt

Ref. 9141 (SF45) - H 43, Ø39 cm y 25kg.
 Ref. 9142 (SF65) - H 53, Ø47 cm y 50kg.
 Ref. 9143 (SF85) - H 65, Ø47 cm y 75kg.
 Ref. 9144 (SF200) - H 78, Ø68 cm y 150kg.

Depósito. Tank. Dépôt

Ref. 9165 (72015) - H 38, Ø32 cm y 20kg.

Sílice. Silica. Silice. Ø 0,4-0,8

Ref. 4872: Aprox. 20 kg.
 Ref. 4871: Aprox. 25 kg.

Ref. 4736
 Manómetro.
 Analog gauge.
 Manomètre.



Ref. 9158
 L. 27,2 cm (72015)
 Tubo difusor. Diffusive
 tube. Tube diffuseur.

Ref. 9151 - L. 30 cm (SF45)
 Ref. 9152 - L. 33 cm (SF65)
 Tubo difusor. Diffusive
 tube. Tube diffuseur.

Ref. 8711 - Ø11 x 20,5 cm.
 Cartucho
 Cartridge.
 Cartouche.

Ref. 8714 - Ø10,7 x 9,4 cm.
 Cartucho
 Cartridge.
 Cartouche.

Ref. 8713 - Ø11 x 20,5 cm.
 Cartucho skimmer filtrante.
 Cartridge skimmer filter.
 Cartouche filtre skimmer.

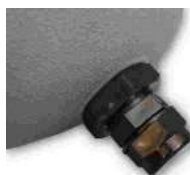

Ref. 9133
 Válvula de descarga.
 Waste valve.
 Soupape de secours.

Ref. 9167
 Válvula de descarga.
 Waste valve.
 Soupape de secours.

Cestillos para motor con prefiltro.
 Baskets for engine's pre-filters.
 Paniers pour les pompes avec pré-filtre.

Ref - 9364 para SP6000
 Ref - 9358 para PP7000
 Ref - 9382 para SP8000
 Ref - 9396 para SP10000 y SP 15000

Tapaderas para el prefiltro.
 Lids for the prefilter of the engines.
 Couvercles pour le pré-filtre du moteur.

Ref - 9362 para SP6000
 Ref - 9359 para PP7000
 Ref - 9383 para SP8000
 Ref - 9391 para SP10000 y SP 15000



Ref. 9132
 Abrazadera de plástico.
 Injected plastic clamp.
 Anneau en plastique injecté.

Ref. 4735 - Ø 16 cm
 Junta tórica.
 O-ring.
 Joint torique.

Ref. 9215 - x10
 Tornillos inox para skimmer.
 Stainless Screws for skimmer.
 Vis inox pour skimmer.

Ref. 9164 - x90
 Tornillos periferia.
 Screws.
 Vis.

CUBIERTAS - COVER - COUVERTURE



TAPIZ

REF.	c m.	
8704	Ø 230	Protege el liner del contacto directo con el suelo. Se sirve en forma rectangular. Material Polietileno.
8706	Ø 320	
8707	Ø 350	It protects the liner from direct contact with the ground. Rectangular shaped. Polyethylene .
8708	Ø 400	
8709	Ø 460	Le tapis protège le liner du contact direct avec le sol. Forme rectangulaire. Matériau: polyéthylène.
8710	Ø 550	
8703	Ø 640	
8739	550x366	
8738	640x366	
8740	730x366	
8741	915x457	
8742	1200x457	

CUBIERTA TUBULARES

REF.	c m.	
4846(4)	190x190	Reduce la suciedad y el mantenimiento hasta en un 50 %.
4834(6)	160 c m.	
4835(6)	200 c m.	Facilidad de colocación con sus pinzas de plástico inyectado.
4847(6)	215 c m.	
4836(6)	230 c m.	Características: Material Polietileno no poroso, de 400 micras.
4837(8)	250 c m.	
4838(8)	300 c m.	

Dirt and reduces maintenance by up to 50%. Ease of installation with injected plastic tweezers. Features: Material non-porous polyethylene, 400 microns.

La bâche réduit l'entretien, (près de 50% moins). Facile à installer, avec des pinces en plastique. Caracteristiques : matériel non poreux en polyéthylène. 400 microns.



CUBIERTA DE INVIERNO

REF.	piscina (c m.)	cubierta (c m.)
4949	Ø 230	Ø 290
4950	Ø 350	Ø 410
4951	Ø 400	Ø 460
4953	Ø 460	Ø 520
4954	Ø 550	Ø 610
4980	Ø 640	Ø 700
4957	550x366	610x426
4958	640x366	700x426
4955	730x366	792x426
4956	915x457	975x517
4959	1200x457	1260x517

Tejido de RAFIA DE POLIETILENO recubierto a una cara con una lámina de polietileno. Resistencia al desgarro. Tratamiento anti UVA. Incluye cable tensor y manual de instalación. Cualidades: Protección contra polvo, hojas, impurezas. Reduce el consumo de productos de tratamiento del agua. El material es opaco.

Polyethylene raffia fabric coated on one side with a polyethylene sheet. Tear resistance. Anti UVA. Includes cable and hand installation tensile. Qualities: Reduce consumption of water treatment products. Opaque material.

Tissu en polyéthylène de raphia revêtu d'un côté avec une feuille de polyéthylène. Résistant à la déchirure et anti-UVA. Y compris un cable tenseur et un manuel d'installation. Qualités: Protection contre la poussière, les feuilles, la saleté. Réduction de la consommation de produits de traitement de l'eau. Matériau opaque.

CUBIERTA ISO TÉRMICA

REF.	c m.
4921	Ø 230
4922	Ø 350
4923	Ø 400
4925	Ø 460
4926	Ø 550
4920	Ø 640
4927	550x366
4930	640x366
4928	730x366
4929	915x457
4931	1200x457

Útiles para cualquier piscina, ya que reduce la suciedad, el mantenimiento y el uso de productos químicos hasta en un 50 %. Características: Material Polietileno no poroso, con burbujas de aire sellado (180 micras). Tratamiento anti UVA.

Useful for anypool, reducing dirt, maintenance and use of chemicals up to 50%. Features: Non-porous polyethylene with sealed bubbles. 180 microns thick. Anti UVA.

Utiles pour toute type de piscine. Réduit la saleté, l'entretien et l'utilisation de produits chimiques jusqu'à 50%. Caracteristiques : Matériau non poreux en polyéthylène à bulles d'air étanche (180 microns).

ACCESORIOS LINERS ESCALERAS - LEADERS - ÉCHELLE



LINERS CIRCULARES

↕ 90 c m. - 35/ 100, 40/ 100

8892	350x90 (0.35/0.40)
8897	400x90 (0.35/0.40)
8893	450x90 (0.35/0.40)

↕ 120 c m. - 35/ 100, 40/ 100

8891	230x120 (0.35/0.40)
8898	350x120 (0.35/0.40)
8894	450x120 (0.35/0.40)
8895	460x120 (0.35/0.40)
8896	550x120 (0.35/0.40)
8900	640x120 (0.35/0.40)

↕ 132 c m. - 40/ 100

8901	350x132 (0.40)
8902	460x132 (0.40)
8903	550x132 (0.40)

ESPESORES SUPERIORES

↕ 120 c m. - 50/ 100, 60/ 100

8924	350x120 (0.50/0.60)
8925	450x120 (0.50/0.60)
8926	460x120 (0.50/0.60)
8927	550x120 (0.50/0.60)



LINERS OVAIADOS

↕ 120 c m. - 35/ 100, 40/ 100, 50/ 100

8955	550x366x120 (0.35/0.40)
8954	640x366x120 (0.35/0.40)
8956	730x366x120 (0.35/0.40)
8957	915x457x120 (0.35/0.40)
8899	1200x457x120(0.50/0.50)

↕ 132 c m. - 40/ 100

8904	550x366x132 (0.40)
8905	640x366x132 (0.40)
8906	730x366x132 (0.40)
8907	915x457x132 (0.40)

ESPESORES SUPERIORES

↕ 120 c m. - 50/ 100, 60/ 100

8920	550x366x120 (0.50/0.60)
8921	640x366x120 (0.50/0.60)
8922	730x366x120 (0.50/0.60)
8923	915x457x120 (0.50/0.60)



LINERS DECORADOS

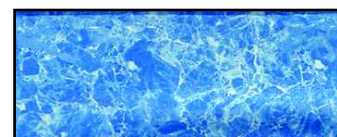

↕ 120 c m. - 50/ 100, 60/ 100

8960	Ø 350x120(0.50/0.60)
8961	Ø 450x120(0.50/0.60)
8963	Ø 550x120(0.50/0.60)



LINERS NATIVA

REF.	c m.
8890	Ø 240x125((0.50/0.60)

Garantía del liner 1 año,
solo soldadura, no
pincellos.

1 years warranty of the liner,
so udure se ulement.

1 ans de garantie de la
ligne, solder only.

ESCALERAS

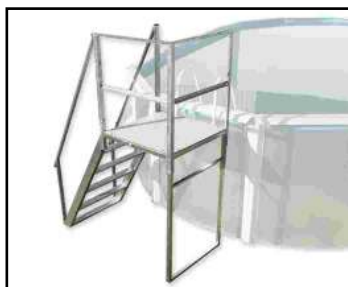

Ref. 4844

Plataforma con escalera para acceder a la piscina de forma fácil y segura. Estructura desmontable en tres piezas, muy fácil de ensamblar.

- Estructura en acero galvanizado.
- Tablero de la plataforma de madera finlandesa.
- Escalones con antideslizantes.

Platform with ladder to access the pool easily and safely. Detachable frame three pieces, easy to assemble.

- Galvanized steel structure.
- Finnish wooden platform.
- Steps to antiskip.

Plate-forme avec échelle pour accéder à la piscine facilement et en toute sécurité. Détachables trame trois morceaux, facile à assembler.

- Structure en acier galvanisé.
- Conseil de la plate-forme en bois finlandaise.
- Étapes à glisser.



Ref. 4839

Escalera galvanizada.
Tubo 25x1 mm.
Peldaño de polipropileno.
Peso máx. 100 kg.
Galvanized pipe 25x1 mm.
Polypropylene step.
Maximum weight: 100 kgs.
Tube galvanisé 25x1 mm.
Échelons en polypropylène.
Poids max.: 100 kgs.



Ref. 4870

Escalera de 8 peldaños lacada epoxi blanco.
Tubo 25x1 mm.
Peldaño de polipropileno.
Peso máx. 100 kg.
White lacquered epoxy ladder.
Pipe 25x1 mm.
Polypropylene step.
Maximum weight: 100 kgs.
Échelle laquée epoxy blanc.
Tube 25x1 mm.
Échelons en polypropylène.
Max. poids: 100 kgs.



Ref. 4876

Escalera con plataforma lacada epoxi blanco.
Tubo 25x1,5 mm.
Peldaño de polipropileno.
Peso máx. 100 kg.
White lacquered epoxy ladder.
Pipe 25x1,5 mm.
Polypropylene step.
Maximum weight: 100 kgs.
Échelle laquée epoxy blanc.
Tube 25x1,5 mm.
Échelons en polypropylène.
Max. poids: 100 kgs.



Manguera destinada a unir el cabezal con el motor.
Hose to link the selector head to the engine.
Tuyau pour lier la vanne multi-voies à la pompe.

Ref.4749 - L. 45 y Ø32 mm (SF25-45)
Ref.9135 - L. 58 y Ø38 mm (SF65-85)
Ref.9136 - L. 95 y Ø38 mm (SF200)



Ref. 9335
Mangueras para el filtro de cartucho de Ø32 mm y 2 metros de longitud.
Hoses for the cartridge filter Ø32 mm and 2 metres.
Tuyau pour le filtre à cartouche Ø 32 mm o 2 m.



Manguera estriada de cuerpo flexible disponible en dos diámetros.
Striated flexible hose, 2 diameters available.
Tuyau flexible et strié avec des raccords, disponibles en 2 diamètres.

Ø 32 mm:
Ref. 4751: L - 4 m. Ø32 mm.
Ref. 4763: L - 25 m. Ø32 mm.
Ref. 4764: L - 100 m. Ø32 mm.

Ø 38 mm:
Ref. 4750: L - 4 m. Ø38 mm.
Ref. 4765: L - 100 m. Ø38 mm.



Manguera estriada de cuerpo flexible de Ø38 mm y racores incorporados. Recomendable para motores de más de 1/2 hp.
Striated flexible hose Ø38 mm, with fittings. Suitable for motors over 1 / 2 hp.
Tuyau flexible et strié Ø38 mm avec des raccords. Pour les pompes de plus de ½ hp.

Ref. 4746: L - 6 m.
Ref. 4747: L - 9 m.
Ref. 4748: L - 12 m.



REF.4826 - Calentador Solar

Calentador solar de fácil instalación aprovecha el efecto invernadero para aumentar su rendimiento. Funciona con el filtro de la piscina.

Capacidad de contener 8 litros, presión máxima 1.5 bar, valido para piscinas de hasta 15 m3, posibilidad de conectar varios calentadores para aumentar la capacidad de calentar. Puede llegar a aumentar la temperatura del agua 5 °C.

Easy installation solar heater approaches the greenhouse to increase performance. Works with pool filter.

Contain 8 liters capacity, maximum pressure 1.5 bar, valid for pools up to 15 m3, ability to connect multiple heaters to increase heat capacity. Can potentially increase the water temperature 5 °C

Facilité d'installation chauffe-eau solaire s'approche de la serre pour augmenter les performances. Fonctionne avec filtre de piscine.

Contenir 8 litres, pression maximale de 1,5 bar, valable pour les piscines jusqu'à 15 m3, capacité de connecter plusieurs appareils de chauffage pour augmenter la capacité de chaleur. Peut potentiellement augmenter la température de l'eau à 5 °C



ACCESORIOS
COMPLEMENTOS



Ref. 4887
Mango telescópico, 1,22 - 2,44 mtrs.
Telescopic stick, 1,22 - 2,44 mtrs.
Manche télescopique, 1,22 - 2,44 mtrs.



Ref. 4889
Recoge hojas.
Collects leaves.
Recueille laisèe.



Ref. 4890
Recoge fondos.
Raises funds
Lève des fonds.



Ref. 4879
Flotador dosificador de pastillas de cloro.
Chlorine tablets floating dispenser.
Doseur de chlore en tablettes flottant.



Ref. 9162
Peldaño escalera de polietileno.
Polyethylene step.
Échelon en polyéthylène.



Ref. 9163
Plataforma escalera de polietileno.
Polyethylene ladder platform.
Echelle plateforme en polyéthylène.



Ref. 4809
Kit de reparación para piscinas de PVC.
Repair kit for PVC pools.
Kit de réparation pour réparer de coupures et des piqûres des liners en PVC.



Ref. 4862
Termómetro flotante.
Floating thermometer.
Thermomètre flottant.



Ref. 4861
Kit Ph y cloro.
Kit Ph and chlorine.
Kit Ph et chlore.



REF.	c m.
4939	Ø230
4940	Ø350
4941	Ø400
4943	Ø460
4944	Ø550
4937	Ø640
4945	550x366
4946	640x366
4947	730x366
4948	915x457
4938	1200x457

Kit de verano compuesto de cubierta isotérmica, termómetro, kit de pH, recoge hojas y dosificador de cloro.

Composed by: isothermal cover (summer cover), thermometer, pH kit, surface net and chlorine dispenser.

Kit d'été compose par: couverture isothermique (bâche d'été), thermomètre, pH kit, épaisseur de surface et doseur de chlore.

Kit de verano. Summer Kit. Kit d'été.



Foco flotante led a batería, ideal para piscinas sin focos, da una luz ambiente válida para piscinas de hasta 9x5 metros. Dispone de 64 leds. Incluye cargador.

LED battery floating focus for pools without lights. It gives an ambient light for pools up to 9 x 5 feet. It has 64 LEDs. Charger included.

Foyer flottant à batterie LED, idéal pour les piscines sans lumières, Qui donne un climat spécial pour les piscines qui mesurent jusqu'à 9 x 5 mètres aprox. Il dispose de 64 LEDs. Le chargeur est inclus.



Válvula con leds super brillantes. No restringe la salida del agua. Fácil instalación.

Six super bright LED Does not restrict water flow. Mounts easily into your return fitting.

Six super bright LED Ne pas limiter le débit d'eau. S'installe facilement dans votre raccord de retour.



Ref. 4881- Foco Leds, Ø30 x 18 c.m.

Ref. 4852 - Válvula con foco.

MANTENIMIENTO- MAINTENANCE - ENTRETIEN



Pastillas de 200 gr. Desinfectante, algicida, floculante, antical y mantenedor del pH.

Tratamiento completo para piscinas con aguas muy duras o difíciles.

Reponer según consumo (6-7 días)

200gr tablets . Disinfectant, algacide, flocculant, pH softener and maintainer.

Full treatment for hard water pools or difficult.

Reset according to consumption (6-7 days)

Comprimés 200 gr. Désinfectant, algicide, floculant, adoucisseur d'pH et responsable.

Traitement complet pour les piscines d'eau dure ou difficile.

Réinitialiser selon consommation (6-7 jours)

Ref. 4724 - PASTILLAS 5 ACCIONES 5 kg.



Valido para cualquier tipo de piscinas, tanto de obra como desmontable.

No necesita bomba adicional, se conecta en la toma de aspiración o en el skimmer.

Requiere una bomba con una potencia mínima de ¼ de Caballo.

Medidas Ø 30 x 22 cm. Se sirve con 10 mtrs de manguera.

Valid for all types of pools, (both on-ground and work).

You don't need additional pump as it's connected to the suction or skimmer.

Requires a pump with a minimum power of ¼ hp.

Measures Ø30 x 22 cms. Served with a 10 mts hose.

Valable pour tous types de piscines (à la fois amovibles et hors-sol).

Vous n'avez pas besoin de pompe supplémentaire car c'est relié à l'aspiration ou au skimmer.

Requiert une pompe avec une puissance minimum de ¼ hp.

Measures 30x22 cms. Servi avec un tuyau de 10 mètres.

Ref. 4865 - LIMPIAFONDOS MARIQUITA



Valido para cualquier tipo de piscinas.

No necesita bomba adicional, se conecta en la toma de aspiración o en el skimmer.

Requiere una bomba con una potencia mínima de 1 de Caballo.

Se sirve con 10 mtrs de manguera.

Valid for all types of pools.

You don't need additional pump as it's connected to the suction or skimmer.

Requires a pump with a minimum capacity of 1 hp.

Served with a 10 mts hose.

Valable pour tous types de piscines.

Vous n'avez pas besoin de pompe supplémentaire car c'est relié à l'aspiration ou au skimmer.

Requiert une pompe avec une puissance minimum de 1 hp.

Servi avec un tuyau de 10 mètres.

Ref. 4857 - LIMPIAFONDOS VENTOSA



No necesita bomba adicional, se conecta en la toma de aspiración o en el skimmer.

Requiere una bomba con una potencia entre 75 W-375 W. Mínimo 4.000L/H.

Se sirve con 6,4 mtrs de manguera.

You don't need additional pump as it's connected to the suction or skimmer.

Requires a pump with a capacity between 75 W-375W. Minimum 4.000L/H.

Served with a 6,4 mts hose.

Vous n'avez pas besoin de pompe supplémentaire car c'est relié à l'aspiration ou au skimmer.

Requiert une pompe avec une puissance entre 75 W-375W. Minimum 4.000L/H

Servi avec un tuyau de 6,4 mètres.

Ref. 4867 - LIMPIAFONDOS ANACONDA

MANTENIMIENTO- MAINTENANCE- ENTRETIEN

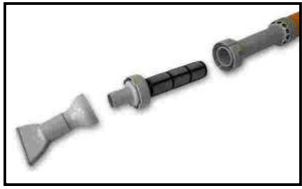

Es un limpia fondos manual simple y eficaz, para piscinas pequeñas, spas, escaleras, rebosaderos.

Los residuos aspirados quedan retenidos en su propio filtro que es muy fácil de limpiar. Para una mayor eficacia, se suministra con una boquilla, un recoge hojas y un cepillo.

El sistema de aspirado es similar al de una jeringuilla.

It's a simple manual bottom cleaner for small pools, spas, ladders, overflows.

Aspirated waste is retained in its own filter, that is easy to clean. For efficiency, it comes with a mouthpiece, a surface net and a brush.

The vacuum system is similar to a syringe's.

Il s'agit d'un simple nettoyeur de fonds manuel. Efficace pour les petites piscines, des spas, des échelles, des débordements.

Les déchets aspirés sont retenus dans son propre filtre, qui est facile à nettoyer. Pour plus d'efficacité, il est livré avec une buse, un drap propre et une brosse.

Le système d'aspiration est semblable à celle-ci d'une seringue.

Ref. 4864 - LIMPIAFONDOS MANUAL EMBOLO



Kit para limpiar el fondo de la piscina manualmente.

El kit consiste en un limpiafondos con cepillo en la base para proteger el liner, una pértiga extensible de 1,22 a 2,44 metros y 6 metros de manguera de Ø32.

Manual bottom cleaner kit, consisting of a vacuum cleaner with brush at the base to protect the liner, an extending stick from 1.22 to 2.44 meters and 6 meters hose, Ø32 mm.

Kit pour le nettoyage du fond de la piscine manuellement.

Le kit se compose de: un aspirateur avec une brosse à la base afin de protéger le liner, une manche télescopique de 1.22 à 2.44 mètres, et un tuyau de 6 mts Ø32 mm diam.

Ref. 4893 - LIMPIAFONDOS MANUAL CEPILLO



Cepillo de limpieza mediante el sistema ventury. Funciona conectando una manguera de riego normal.

Cleaning brush through the ventury system. It works by connecting a normal garden hose.

Brosse de nettoyage à travers le système ventury. Il fonctionne en connectant un tuyau d'arrosage normal.

Ref. 4858 - CEPILLO VENTURY



Limpiafondos con cepillos en la base para proteger el suelo de la piscina.

Bottom cleaner with brush in the base, to protect the floor of the pool.

Brosse de nettoyage à la base afin de protéger le sol de la piscine.

Ref. 4860 - LIMPIAFONDOS "RIÑÓN"

TRATAMIENTO SIN CLORO

NON-CHLORINE
SANS CHLORE



Ref. 4710

OXÍGENO ACTIVO 500 gr.

Desinfectante para piscinas incoloro, inoloro e inocuo. No irrita los ojos.

ACTIVE OXYGEN 500 gr.

Disinfectant for swimming pools. Colorless, odorless and harmless. No eye irritation.

OXYGÈNE ACTIF 500 gr.

Désinfectant pour piscines incolore, sinodore et inoffensive. Pas d'irritation des yeux.



Ref. 4711

ALGICIDA OXÍGENO TRATAMIENTO SIN CLORO 500 ml.

Se usa unicamente con el tratamiento de Oxígeno Activo.

OXYGEN TREATMENT ALGICID CHLORINE 500 ml.

It's used solely with the "Active Oxygen Treatment".

TRAITEMENT PAR L'OXYGÈNE ALGICID CHLORE 500 ml.

Il est utilisé uniquement avec le traitement d'oxygène actif.



Ref. 4716

OXÍGENO LÍQUIDO 1.000 ml.

Producto líquido de alto poder oxidante para tratamiento sin cloro del agua de las piscinas.

LIQUID OXYGEN 1.000 ml.

For non-chlorine treatments of pools.

OXYGÈNE LIQUIDE 1.000 ml.

Produit liquid avec un haut pouvoir oxidant. Traitement de l'eau des piscines, sans chlore.



Ref. 4842

BIOPOOL 5 ACCIONES 1.000 ml + OXIPOOL 500gr.

-Sustituye la acción del cloro.
-Acción antialgas.
-Efecto floculante.
-Estabilizador del pH.
-Efecto antical.

-Replaces the action of chlorine.
-Action algae.
-Effect flocculant.
-PH-stabilizer.
-Calc-Effect.

-Remplace l'action du chlore.
-Action-algues.
-Effet floculant.
-Stabilisateur de pH.
-Calc-effet.

TRATAMIENTO CON CLORO

WITH CHLORINE
AVEC CHLORE



Ref. 4715

CLORO LÍQUIDO 1.000 ml.
Hipoclorito sódico de alta concentración para la desinfección diaria del agua de la piscina.

LIQUID CHLORINE 1.000 ml.
High concentration sodium hypochlorite for a daily disinfection of the pool water.

CHLORE LIQUIDE 1.000 ml.
Haute concentration de l'hypochlorite de sodium pour la désinfection quotidienne de la piscine.



Ref. 4719

CLORO RÁPIDO 500gr.

Cloro de disolución rápida con alto poder desinfectante.

FAST CHLORINE 500gr.

Fast-dissolving chlorine with high disinfecting power.

CHLORE RAPIDE 500gr.

Du chlore à dissolution rapide avec une haute puissance de désinfection.



Ref. 4720

CLORO PASTILLAS 400 gr.
Cloro de disolución rápida en tabletas para la desinfección del agua. 20 pastillas de 20 gr.

CHLORINE TABLETS 400 gr.
Fast-dissolving chlorine tablets for water disinfection. 20 pills of 20 gr each.

TABLETTES DE CHLORE 400 gr.
Dissolution rapide des comprimés de chlore pour la désinfection de l'eau. 20 comprimés de 20 gr.



Ref. 4712

ALGICIDA 500 ml.
El algicida evita y elimina la formación de algas, bacterias y hongos causantes de coloraciones verdosas.

500 ml ALGICID.
The algaecide prevents and eliminates the formation of algae bacteria and fungi green.

500 ml ALGICID.
Prévient et élimine la formation d'algues, les bactéries et les fungi verts.



Ref. 4724

PASTILLAS 5 ACCIONES 5 kg.
Desinfectante, algicida, floculante, antical y mantenedor del pH.

PADS 5 ACTIONS 5 kg.
Disinfectant, algaecide, flocculant, pH softener and maintainer.

PADS 5 ACTIONS 5 kg.
Désinfectant, algicide, flocculant, adoucisseur d'pH et responsable.

REGULADORES DE PH NON-CHLORINE SANS CHLORE



Ref. 4717

-PH GRANULADO 500 gr.

Producto granulado para bajar el pH del agua. Cuando el pH está alto el cloro trabaja solo al 20% y se nos in crustará cal.

-PH GRANULES 500 gr.

Granulated product to lower the pH of the water. When the pH is high chlorine works only 20% and lime can get incrustated.

-PH GRANULES 500 gr.

Produit granulé pour abaisser le pH de l'eau. Quand le pH est élevé, le chlore ne fonctionne que au 20% rendement et la chaux peut s'incruster.



Ref. 4718

+PHGRANULADO 500 gr.

Producto granulado para subir el pH del agua. Cuando el pH está bajo el agua es ácida y pican los ojos y la piel y se oxidan los materiales

+ PHGRANULADO 500 gr.

Granulated product to raise the pH degree in water. When pH is low, the water is acid so eyes and skin irritates and materials oxydate.

+ PHGRANULADO 500 gr.

Produit granule pour élever le pH de l'eau. Quand le niveau de pH est bas, les yeux et la peau s'irritent et les matériaux s'oxydent.

LIMPIADORES NON-CHLORINE SANS CHLORE



Ref. 4713

LIMPIADOR LÍNEA DE FLOTACIÓN 500 ml.

Producto detergente para la limpieza de la suciedad, aceites y grasas adheridas a la pared.

WATERLINE CLEANER 500 ml.

Detergents for cleaning dirt, oil and grease adhering to the wall.

NETTOYANT WATERLINE 500 ml.

Détergents pour le nettoyage de la saleté, huile et graisse adhérant à la paroi.



Ref. 4714

LIMPIADOR LINER 500 ml.

Producto detergente ácido desincrustante, diseñado para la limpieza y desincrustación de la suciedad del liner.

LINER CLEANER 500 ml.

Descaling acid detergent product designed for cleaning and descaling the dir from the liner.

NETTOYANT LINER 500 ml.

Détergent acide désincrustant, conçu pour nettoyer et détartrer la saleté du liner.

TRATAMIENTO EN KIT TREATMENT KIT KIT DE TRAITEMENT



Ref. 4722

KIT MINI PISCINAS.

Mantenimiento para piscinas hinchables y portátiles. Cloro rápido 500 ml + Algicida 500gr.

MINI POOL KIT.

Maintenance for inflatable and portable pools. Quick Chlorine Algaecide 500 ml + 500gr.

KIT MINIPISCINE

Maintenance des piscines gonflables et portables. Chlore rapide 500 ml + Algicide 500 ml.



Ref. 4723

FULL EQUIPE.

Tratamiento para piscinas portátiles. Cloro en tabletas 20 gr. + Algicida líquido. Dosificador flotante incluido.

Treatment for portable pools. Chlorine tablets 20 grs + Algaecide liquid. Floating chlorine dispenser included.

Traitement pour les piscines auto-portables. Comprimés de chlore 20 gr + Algicide liquide. Doseur de chlore inclus.