

2014

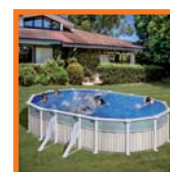



<b>PRESENTACIÓN</b>	<b>2</b>	<b>PRESENTATION</b>	
<b>NOVEDADES</b>	<b>3</b>	<b>NEW PRODUCTS</b>	
<b>PISCINAS DE MADERA</b>	<b>4</b>	<b>WOODEN COVERING POOLS</b>	
Serie Hawaii	<b>6</b>	Serie Hawaii	
Serie Island	<b>8</b>	Serie Island	
<b>PISCINAS DE ACERO</b>	<b>10</b>	<b>STEEL WALL POOLS</b>	
Serie Celosia	<b>12</b>	Serie Celosia	
Serie Capri	<b>14</b>	Serie Capri	
Serie Mykonos - Skyathos	<b>16</b>	Serie Mykonos - Skyathos	
Serie Iraklion	<b>18</b>	Serie Iraklion	
Serie Amazonia - Mauritius	<b>20</b>	Serie Amazonia - Mauritius	
Serie Galapagos	<b>22</b>	Serie Galapagos	
Serie Madeira	<b>24</b>	Serie Madeira	
Serie Haiti - Atlantis	<b>26</b>	Serie Haiti - Atlantis	
Serie Bali	<b>28</b>	Serie Bali	
Serie Varadero - Cies	<b>30</b>	Serie Varadero - Cies	
Serie Lanzarote - Tenerife - Formentera	<b>32</b>	Serie Lanzarote - Tenerife - Formentera	
<b>JET POOL</b>	<b>34</b>	<b>JET POOL</b>	
<b>COMPLEMENTOS</b>	<b>36</b>	<b>COMPLEMENTS</b>	
Cubiertas isotérmicas	<b>38</b>	Isothermic covers	
Cubiertas de invierno	<b>39</b>	Winter covers	
Mantas	<b>40</b>	Bottom protective blanket	
Liners	<b>41</b>	Liners	
Escaleras para piscinas enterradas	<b>42</b>	Inground pool ladders	
Escaleras para piscinas sobre suelo	<b>43</b>	Above-ground pool ladders	
Monoblocs de filtración	<b>44</b>	Filtration kit	
Filtro de arena		Sand filter	
Cargas filtrantes	<b>46</b>	Filter media	
Local técnico		Technical room	
Skimmers	<b>47</b>	Skimmers	
Filtros de cartucho	<b>48</b>	Cartridge filter	
Cartuchos		Cartridges	
Bombas	<b>49</b>	Pumps	
Tratamiento de agua	<b>50</b>	Water treatment	
Electrolisis de sal		Electrolysis of salt	
Sistemas de desinfección y dosificación	<b>51</b>	Disinfection and dosing systems	
Calefacción	<b>52</b>	Heating systems	
Calefacción solar	<b>53</b>	Solar heating system	
Material eléctrico	<b>54</b>	Electrical equipment	
Iluminación		Lighting	
Duchas	<b>56</b>	Showers	
Enrolladores de cubiertas	<b>59</b>	Telescopic cover rollers	
Repuestos	<b>60</b>	Spare parts	
<b>MATERIAL DE LIMPIEZA</b>	<b>62</b>	<b>CLEANING MATERIAL</b>	
Leyenda y Formatos	<b>65</b>	Legend and formats	
Robots	<b>66</b>	Robots	
Recambios	<b>69</b>	Spare filtration bags	
impiafondos automáticos	<b>70</b>	Automatic cleaners	
Kits limpiafondos de aspiración	<b>72</b>	Vacuum cleaners kits	
Limpiafondos Ventury	<b>74</b>	Ventury vacuum	
Gama Superluxe	<b>75</b>	Superluxe range	
Limpiafondos manuales	<b>76</b>	Vacuum heads	
Cepillos	<b>77</b>	Brushes	
Dosificadores	<b>78</b>	Dispensers	
Termómetros	<b>79</b>	Thermometers	
Mangos telescópicos		Telescopic handles	
Recogehojas	<b>80</b>	Leaf nets and rakes	
Mangueras flotantes	<b>81</b>	Vacuum hoses	
Racordería	<b>84</b>	Winter protection	
Protección invierno	<b>85</b>	Fittings	
<b>PRODUCTO QUÍMICO</b>	<b>86</b>	<b>CHEMICALS</b>	
Cuidado de su piscina	<b>88</b>	Take care of your swimming pool	
Producto Químico GRE	<b>90</b>	GRE brand chemicals	
Cálculo de volumen	<b>92</b>	Calculate the volume	
Reguladores de pH	<b>93</b>	pH regulators	
Desinfectantes	<b>94</b>	Disinfectants	
• Cloro choque		• Shock chlorine	
• Cloro lento		• Trichlorine	
• Bromo	<b>95</b>	• Bromine	
• Oxígeno		• Active oxygen	
• Multi funciones	<b>96</b>	• Multiactions	
Tratamiento antialgas	<b>98</b>	Anti-algae treatment	
Floculante	<b>99</b>	Flocculant	
Productos complementarios	<b>100</b>	Complementary products	
Productos para el invierno	<b>101</b>	Chemical products for winter	
Soluciones de tratamiento	<b>104</b>	Treatment solutions	
Analizadores	<b>106</b>	Test kits	
Tiras de análisis		Test strips	





## Presentación de la empresa

---

Gre es una empresa con más de 50 años de experiencia en la fabricación de piscinas elevadas.

Como empresa pionera en el sector, somos ESPECIALISTAS y LIDERES a nivel EUROPEO.

Nuestra apuesta clara por la CALIDAD y SEGURIDAD de todos nuestros productos , nos convierte en la REFERENCIA fundamental del mercado.

Nuestra empresa ofrece una AMPLIA GAMA de productos: piscinas elevadas de diferentes formatos y acabados, una completa línea de accesorios para su equipamiento y mantenimiento y una serie de productos químicos diseñados específicamente para el agua de la piscina.

Con el ánimo siempre, de satisfacer al cliente, Gre ha diseñado una estrategia de SERVICIOS, cuyo objetivo es ofrecer una solución integral. Nuestra amplia red de Servicios Técnicos, así como nuestros Departamentos de Atención al Cliente, son la mejor prueba de ello. Estos servicios nos permiten asesorarle sobre la opción de piscina y equipamiento más adecuados a sus necesidades.

La constante preocupación de Gre por la mejora en la calidad, por el medio ambiente y el reciclaje de todos sus envases y productos, le ha llevado a ser merecedor de las más importantes certificaciones: ISO 9001, ISO 14001, NF P 90-303, NF P 90-316 y NF P 90-317.

## Company presentation

---

Gre is a company with more than 50 years experience in manufacturing above-ground pools.

As a pioneer company on its field, we are SPECIALISTS and LEADERS within the European market.

We are considered to be a fundamental market REFERENCE as a result of our clear wager on QUALITY and SECURITY of all our products.

Our company offers a WIDE RANGE of products which includes: different sizes and finishes above-ground pools, a complete range of accessories for their equipment and maintenance and a number of swimming pool chemicals designed specifically for the pool water.

Bearing in mind our customers satisfaction, Gre has designed an important SERVICES strategy whose aim is to offer an integral solution. Our wide network of Technical Services and our Customer Service Departments are the best proof of that. These services help us to identify our customers needs and to advice them on the best pool and equipment according to those needs.

Gre concern about quality improvement, environment and recycling of its packaging and products, has resulted in obtaining the most important certificates: ISO 9001, ISO 14001, NF P 90-303, NF P 90-316 and NF P 90-317.



# Novedades New products

## Piscinas Pools



## Bomba Pump



## Intercambiador de calor Electrical heat exchanger



## Skimmer Skimmer



## Monobloc de filtración Filtration kit



Con temporizador  
With timer

## Disinfección y dosificación Disinfection systems



## Robots Robots



## Electrolisis salina Electrolysis of salt

## Limpiafondos Ventury Vacuum



Con control de PH  
With pH control

## Duchas Showers



## Iluminación Lighting

## Tester digital Digital tester



## Producto químico Chemicals







# NATURE POOL

## PISCINA DE PARED DE ACERO CON REVESTIMIENTO DE MADERA

- LINER:** TRATAMIENTO ANTI - ULTRAVIOLETA - RETRASA EL ENVEJECIMIENTO DEL P.V.C.  
**CHAPA:** LAMINADA EN FRIO CON TRATAMIENTO DE GALVANIZACIÓN, FOSFATACIÓN E IMPRIMACIÓN. PERFILACIÓN VERTICAL DE LA MISMA PARA LA OBTENCIÓN DE UNA MAYOR RESISTENCIA. TROQUELADA PARA SKIMMER Y VÁLVULA DE RETORNO DEL AGUA.  
**MADERA:** MADERA DE PINO NÓRDICO , CON TRATAMIENTO NIVEL IV CLASE V , SEGÚN NORMA EUROPEA EN-335. TROQUELADA PARA SKIMMER Y VÁLVULA DE RETORNO DEL AGUA.

## STEEL WALL POOL WITH WOODEN COVERING

- LINER:** ANTI-ULTRAVIOLET TREATMENT TO SLOW DOWN P.V.C AGING.  
**PLATE:** GALVANIZED, PHOSPHATIZED, PRIMED AND LACQUERED COLD-ROLLED PLATE. VERTICAL SECTIONING FOR AN INCREASED STRENGTH. DIE CUT FOR SKIMMER AND WATER RETURN VALVE OPENINGS.  
**WOOD:** NORDIC PINE WOOD WITH LEVEL IV TREATMENT ACCORDING TO EN-335 EUROPEAN STANDARD.



# NATURE POOL



- Liner cenefa 50/100
- Tapas metal lacado
- Perfilera de madera
- Frieze liner 50/100
- Lacquered metal covers
- Wooden frames



Tinte Woodstainer



NP611

**KITNPOV731**  
**KITNPOV611**

Sistema de omegas **Omega system**



NP461

**KITNP461**





# SERIE HAWAII

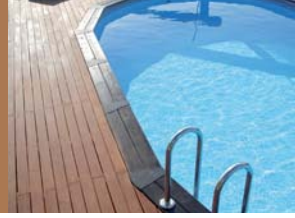

- Depuradora arena  
- Caudal grupo 7 m<sup>3</sup>/h
- Escalera:  
- Madera / acero inoxidable
- Manta protectora  
- Poliéster
- Limpiafondos automático
- Sand filter  
- Flow group 7 m<sup>3</sup>/h
- Ladder:  
- Bois / stainless steel
- Bottom protective blanket  
- Polyester
- Automatic pool cleaner

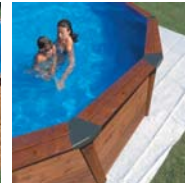

750x425 cm	132 cm	28.050 l	497/498 kg	1/120x80 - 1/134x116	7m <sup>3</sup> /h	√	√	28	19,5/22	227726
640x425 cm	132 cm	23.230 l	411/421 kg	1/120x80 - 1/134x116	7m <sup>3</sup> /h	√	√	28	19,5/22	227733



- Depuradora arena  
- Sílex 5 m<sup>3</sup>/h
- Escalera:  
- Madera / acero inoxidable
- Manta protectora  
- Poliéster
- Limpiafondos automático
- Sand filter  
- Sílex 5 m<sup>3</sup>/h
- Ladder:  
- Bois / stainless steel
- Bottom protective blanket  
- Polyester
- Automatic pool cleaner

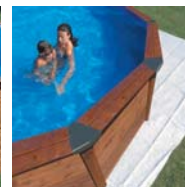

Ø500 cm	132 cm	20.270 l	217/385 kg	1/90x80 - 1/134x116	5m <sup>3</sup> /h	√	√	28	19,5	227764
---------	--------	----------	------------	---------------------	--------------------	---	---	----	------	--------



	Medida piscina Pool size cm	Espacio necesario Necessary space cm
KITNPOV911	930x515	950x550
KITNPOV811	820x515	900x550
KITNPOV731	750x425	800x450
KITNPOV611	640x425	700x450



	Medida piscina Pool size cm	Espacio necesario Necessary space cm
KITN461	Ø 500	510x510



- Liner azul 40/100
- Tapas metal lacado
- Perfileria de madera
- Blue liner 40/100
- Lacquered metal covers
- Wooden frames



Tinte  
Woodstainer



DVD  
VIDEO



**KITNPOV732**  
**KITNPOV612**  
**KITNPOV502**



NPOV612

Sistema de omegas Omega system



NP352A



KITNP352(A) - KITNP242(A)  
Liner azul 30/100  
KITNP352(A) - KITNP242(A)  
Blue liner 30/100



**KITNP462**  
**KITNP352A**  
**KITNP242A**  
**KITNP352**  
**KITNP242**



# serie Island



- Depuradora arena
  - Caudal grupo 5, 4, 3 m<sup>3</sup>/h
- Escalera:
  - Madera / acero inoxidable
- Tapiz de suelo
  - Polietileno 115 g/m<sup>2</sup>
- Sand filter
  - Flow group 5, 4 and 3 m<sup>3</sup>/h
- Ladder:
  - Bois / stainless steel
- Floor tapestry
  - Polythene 115 g/m<sup>2</sup>

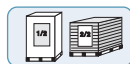

745x420 cm	120 cm	25.180 l	482/404 kg	1/90x80 - 1/124x116	5m <sup>3</sup> /h	√	√	24	19,5/22	224923
635x420 cm	120 cm	20.890 l	378/366 kg	1/90x80 - 1/124x116	4m <sup>3</sup> /h	√	√	24	19,5/22	220093
535x345 cm	120 cm	14.000 l	352/356 kg	1/90x80 - 1/124x116	3m <sup>3</sup> /h	√	√	24	14,5/22	220109

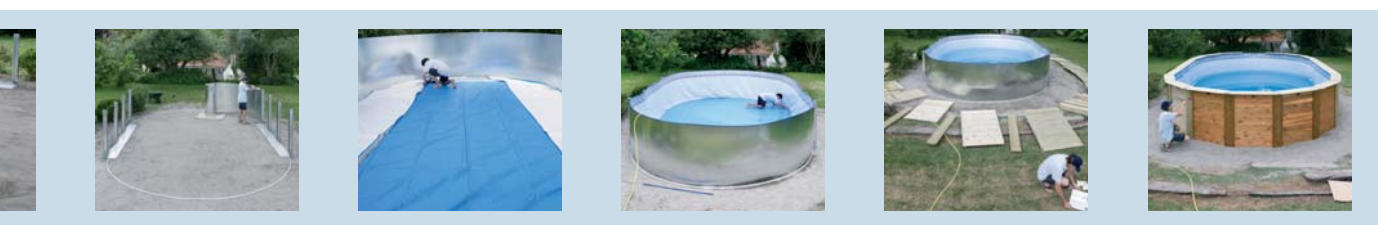

- Depuradora arena
  - Caudal grupo 3 m<sup>3</sup>/h
- Filtro cartucho 3,8 m<sup>3</sup>/h
- Escalera:
  - Madera / acero inoxidable
- Tapiz de suelo
  - Polietileno 115 g/m<sup>2</sup>
- Sand filter
  - Flow group 3 m<sup>3</sup>/h
- Cartridge filter 3,8m<sup>3</sup>/h
- Ladder:
  - Bois / stainless steel
- Floor tapestry
  - Polythene 115 g/m<sup>2</sup>



Ø490 cm	120 cm	17.450 l	199/337 kg	1/80x60 - 1/124x116	3m <sup>3</sup> /h	-	√	√	24	19,5	220123
Ø390 cm	120 cm	10.102 l	185/221 kg	1/80x60 - 1/124x116	3m <sup>3</sup> /h	-	√	√	24	14,5	224930
Ø280 cm	120 cm	4.750 l	159/219 kg	1/80x60 - 1/124x94,5	3m <sup>3</sup> /h	-	√	√	24	14,5	230924
Ø390 cm	120 cm	10.102 l	176/221 kg	1/80x40 - 1/124x116	- 3,8m <sup>3</sup> /h	√	√	24	14,5	220130	
Ø280 cm	120 cm	4.750 l	151/219 kg	1/80x40 - 1/124x94,5	- 3,8m <sup>3</sup> /h	√	√	24	14,5	230917	



Medida piscina  
Pool size  
cm

Espacio necesario  
Necessary space  
cm

KITNPOV732	745x420	800x450
KITNPOV612	635x420	700x450
KITNPOV502	535x345	600x375



Medida piscina  
Pool size  
cm

Espacio necesario  
Necessary space  
cm

KITNP462	Ø 490	510x510
KITNP352/KITNP352A	Ø 390	410x410
KITNP242/KITNP242A	Ø 280	300x300







# DREAM POOL

## PISCINA DE PARED DE ACERO

- LINER:** TRATAMIENTO ANTI - ULTRAVIOLETA - RETRASA EL ENVEJECIMIENTO DEL P.V.C.  
**CHAPA:** LAMINADA EN FRÍO CON TRATAMIENTO DE GALVANIZACIÓN, FOSFATACIÓN, IMPRIMACIÓN Y LACADO. PERFILACIÓN VERTICAL DE LA MISMA PARA LA OBTENCIÓN DE UNA MAYOR RESISTENCIA. TROQUELADA PARA SKIMMER Y VÁLVULA DE RETORNO DEL AGUA.  
**PERFILES:** DE ACERO Y DE P.V.C.

## STEEL WALL POOL

- LINER:** ANTI-ULTRAVIOLET TREATMENT TO SLOW DOWN P.V.C AGING.  
**PLATE:** GALVANIZED, PHOSPHATIZED, PRIMED AND LACQUERED COLD-ROLLED PLATE. VERTICAL SECTIONING FOR AN INCREASED STRENGTH. DIE CUT FOR SKIMMER AND WATER RETURN VALVE OPENINGS.  
**PROFILES:** METAL OR P.V.C



# DREAM POOL

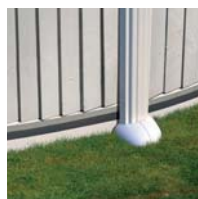

- Liner PVC azul 40/100
- Perfilería acero
- Protectores inyección
- PVC blue liner 40/100
- Steel profiles
- Injection saver



PROV618C

**KITPROV738C**  
**KITPROV618C**



PR558C

**KITPR558C**  
**KITPR458C**



	Medida piscina Pool size cm	Espacio necesario Necessary space cm
<b>KITPROV738C</b>	<b>730x375</b>	<b>770x595</b>
<b>KITPROV618C</b>	<b>610x375</b>	<b>650x595</b>

# SERIE CELOSIA



- Depuradora arena
  - Caudal grupo 5 m<sup>3</sup>/h
- Escalera de seguridad
  - Plataforma +2x3 Peldaños
- Tapiz de suelo
  - Polietileno 115 g/m<sup>2</sup>
- Sand filter
  - Flow group 5 m<sup>3</sup>/h
- Safety Ladder
  - Platform + 2x3 Steps
- Floor tapestry
  - Polythene 115 g/m<sup>2</sup>



730x375 cm	132 cm	28.217 l	335 kg	1/120x80	5m <sup>3</sup> /h	√	√	15	12	241661
610x375 cm	132 cm	23.281 l	270 kg	1/90x80	5m <sup>3</sup> /h	√	√	15	12	241678



Ø 550 cm	132 cm	27.798 l	243 kg	1/90x80	5m <sup>3</sup> /h	√	√	15	12	241685
Ø 460 cm	132 cm	19.444 l	238 kg	1/90x80	5m <sup>3</sup> /h	√	√	15	12	241692



Medida piscina  
Pool size  
cm

Espacio necesario  
Necessary space  
cm

KITPR558C

550 ø

600x600

KITPR458C

460 ø

500x500



- Liner PVC azul 30/100 (KIT730C-KIT610C: 40/100)
- Perfilera acero
- Protectores inyección
- PVC blue liner 30/100 (KIT730C-KIT610C: 40/100)
- Steel profiles
- Injection saver



610C

**KIT730C**

**KIT610C**



350C

**KIT460C**

**KIT350C**



	Medida piscina Pool size cm	Espacio necesario Necessary space cm
<b>KIT730C</b>	<b>730x375</b>	<b>770x595</b>
<b>KIT610C</b>	<b>610x375</b>	<b>650x595</b>





- Depuradora arena
  - Caudal grupo 4 y 3 m<sup>3</sup>/h
  - Escalera de seguridad
  - 2x3 Peldaños
- Sand filter
  - Flow group 4 and 3 m<sup>3</sup>/h
  - Safety Ladder
  - 2x3 Steps



730x375 cm	120 cm	25.323 l	287 kg	1/90x80	4m <sup>3</sup> /h	✓	15	12	250625
610x375 cm	120 cm	20.893 l	235 kg	1/80x60	3m <sup>3</sup> /h	✓	15	12	250632

Ø 460 cm	120 cm	17.450 l	172 kg	1/80x60	3m <sup>3</sup> /h	✓	15	12	250649
Ø 350 cm	120 cm	10.102 l	146 kg	1/80x60	3m <sup>3</sup> /h	✓	15	12	250656

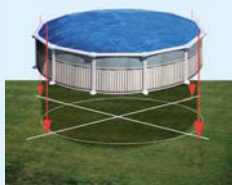

	Medida piscina Pool size cm	Espacio necesario Necessary space cm
KIT460C	460 ø	500x500
KIT350C	350 ø	400x400

# DREAM POOL



- Liner PVC azul 40/100
- Perfilera acero
- Protectores inyección
- PVC blue liner 40/100
- Steel profiles
- Injection saver



PROV6188P

**KITPROV7388P**

**KITPROV6188P**



**Sistema de Omegas**  
Omega system



PROV618P

**KITPROV738P**

**KITPROV618P**



PR558P



# SERIE MYKONOS



- Depuradora arena
  - Caudal grupo 5 m<sup>3</sup>/h
- Escalera de seguridad
  - Plataforma + 2x3 Peldaños
- Tapiz de suelo
  - Polietileno 115 g/m<sup>2</sup>
- Sand filter
  - Flow group 5 m<sup>3</sup>/h
- Safety Ladder
  - Platform + 2x3 Steps
- Floor tapestry
  - Polythene 115 g/m<sup>2</sup>

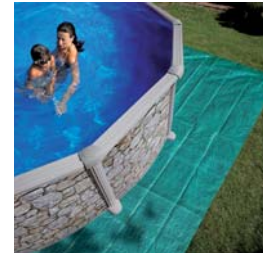

730x375 cm	132 cm	28.217 l	462 kg	1/120x80	5m <sup>3</sup> /h	✓	✓	15	12	230849
610x375 cm	132 cm	23.281 l	437 kg	1/90x80	5m <sup>3</sup> /h	✓	✓	15	12	230856

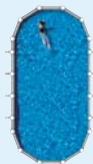

	Medida piscina Pool size cm	Espacio necesario Necessary space cm
<b>KITPROV7388P</b>	<b>730x375</b>	<b>770x495</b>
<b>KITPROV6188P</b>	<b>610x375</b>	<b>650x495</b>

# SERIE SKYATHOS



730x375 cm	132 cm	28.217 l	335 kg	1/120x80	5m <sup>3</sup> /h	✓	✓	15	12	230870
610x375 cm	132 cm	23.281 l	270 kg	1/90x80	5m <sup>3</sup> /h	✓	✓	15	12	230887

Ø 550 cm	132 cm	27.798 l	243 kg	1/90x80	5m <sup>3</sup> /h	✓	✓	15	12	230894
Ø 460 cm	132 cm	19.444 l	238 kg	1/90x80	5m <sup>3</sup> /h	✓	✓	15	12	230900
Ø 350 cm	132 cm	11.250 l	184 kg	1/90x80	5m <sup>3</sup> /h	✓	✓	15	12	233888



	Medida piscina Pool size cm	Espacio necesario Necessary space cm
<b>KITPROV738P</b>	<b>730x375</b>	<b>770x595</b>
<b>KITPROV618P</b>	<b>610x375</b>	<b>650x595</b>



	Medida piscina Pool size cm	Espacio necesario Necessary space cm
<b>KITPR558P</b>	<b>550 Ø</b>	<b>600x600</b>
<b>KITPR458P</b>	<b>460 Ø</b>	<b>500x500</b>
<b>KITPR358P</b>	<b>350 Ø</b>	<b>400x400</b>





- Liner PVC azul 30/100 (KIT730P-KIT610P: 40/100)
- Perfilería acero
- Protectores inyección
- PVC blue liner 30/100 (KIT730P-KIT610P: 40/100)
- Steel profiles
- Injection saver



730P

**KIT730P**  
**KIT610P**  
**KIT500P**



460P

**KIT460P**  
**KIT350P**  
**KIT240P**

























# serie Iraklion



- Depuradora arena
    - Caudal grupo 4 e 3 m<sup>3</sup>/h
  - Escalera de seguridad:
    - 2x3 Peldaños
- Sand filter
    - Flow group 4 and 3 m<sup>3</sup>/h
  - Safety Ladder
    - 2x3 Steps



									
730x375 cm	120 cm	25.323 l	287 kg	1/90x80	4m <sup>3</sup> /h	√	15	12	237558
610x375 cm	120 cm	20.893 l	235 kg	1/80x60	3m <sup>3</sup> /h	√	15	12	233581
500x300 cm	120 cm	14.550 l	224 kg	1/80x60	3m <sup>3</sup> /h	√	15	12	233598

									
Ø 460 cm	120 cm	17.450 l	172 kg	1/80x60	3m <sup>3</sup> /h	√	15	12	233376
Ø 350 cm	120 cm	10.102 l	146 kg	1/80x60	3m <sup>3</sup> /h	√	15	12	233611
Ø 240 cm	120 cm	4.750 l	126 kg	1/80x60	3m <sup>3</sup> /h	√	15	12	237718



	Medida piscina Pool size cm	Espacio necesario Necessary space cm
KIT730P	730x375	770x595
KIT610P	610x375	650x595
KIT500P	500x300	540x520



	Medida piscina Pool size cm	Espacio necesario Necessary space cm
KIT460P	460 Ø	500x500
KIT350P	350 Ø	400x400
KIT240P	240 Ø	300x300

# DREAM POOL



- Liner PVC azul 40/100
- Perfilera acero
- Protectores inyección
- PVC blue liner 40/100
- Steel profiles
- Injection saver



PROV6188W

**KITPROV7388W**

**KITPROV6188W**



**Sistema de Omegas**  
Omega system



PROV618W

**KITPROV738W**

**KITPROV618W**



PR558W

**KITPR558W**

**KITPR458W**

**KITPR358W**



# SERIE AMAZONIA



- Depuradora arena
  - Caudal grupo 5 m<sup>3</sup>/h
- Escalera de seguridad:
  - Plataforma + 2x3 Peldaños
- Tapiz de suelo
  - Polietileno 115 g/m<sup>2</sup>

- Sand filter
  - Flow group 5 m<sup>3</sup>/h
- Safety Ladder
  - Platform + 2x3 Steps
- Floor tapestry
  - Polythene 115 g/m<sup>2</sup>

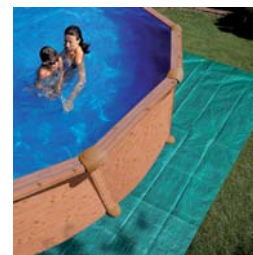

730x375 cm	132 cm	28.217 l	462 kg	1/120x80	5m <sup>3</sup> /h	✓	✓	15	12	227436
610x375 cm	132 cm	23.281 l	437 kg	1/90x80	5m <sup>3</sup> /h	✓	✓	15	12	227443



	Medida piscina Pool size cm	Espacio necesario Necessary space cm
<b>KITPROV7388W</b>	<b>730x375</b>	<b>770x495</b>
<b>KITPROV6188W</b>	<b>610x375</b>	<b>650x495</b>

# SERIE MAURITIUS



730x375 cm	132 cm	28.217 l	335 kg	1/120x80	5m <sup>3</sup> /h	✓	✓	15	12	227634
610x375 cm	132 cm	23.281 l	270 kg	1/90x80	5m <sup>3</sup> /h	✓	✓	15	12	227641

Ø 550 cm	132 cm	27.798 l	243 kg	1/90x80	5m <sup>3</sup> /h	✓	✓	15	12	227450
Ø 460 cm	132 cm	19.444 l	238 kg	1/90x80	5m <sup>3</sup> /h	✓	✓	15	12	227467
Ø 350 cm	132 cm	11.250 l	184 kg	1/90x80	5m <sup>3</sup> /h	✓	✓	15	12	233871



	Medida piscina Pool size cm	Espacio necesario Necessary space cm
<b>KITPROV738W</b>	<b>730x375</b>	<b>770x595</b>
<b>KITPROV618W</b>	<b>610x375</b>	<b>650x595</b>



	Medida piscina Pool size cm	Espacio necesario Necessary space cm
<b>KITPR558W</b>	<b>550 Ø</b>	<b>600x600</b>
<b>KITPR458W</b>	<b>460 Ø</b>	<b>500x500</b>
<b>KITPR358W</b>	<b>350 Ø</b>	<b>400x400</b>





- Liner PVC azul 30/100 (KIT730WE-KIT610WE: 40/100)
- Perfilería acero
- Protectores inyección
- PVC blue liner 30/100 (KIT730WE-KIT610WE: 40/100)
- Steel profiles
- Injection saver



610WE

- ◆ KIT730WE
- ◆ KIT610WE
- ◆ KIT500WE



460WE

- ◆ KIT460WE
- ◆ KIT350WE
- ◆ KIT240WE













# serie galapagos













- Depuradora arena
- Caudal grupo 4 m<sup>3</sup>/h
- Escalera:
- 2x3 Peldaños

- Sand filter
- Flow group 4 m<sup>3</sup>/h
- Ladder
- 2x3 Steps



									
730x375 cm	120 cm	25.323 l	287 kg	1/90x80	4m <sup>3</sup> /h	√	15	12	252445
610x375 cm	120 cm	20.893 l	235 kg	1/80x60	4m <sup>3</sup> /h	√	15	12	252438
500x300 cm	120 cm	14.550 l	224 kg	1/80x60	4m <sup>3</sup> /h	√	15	12	251141

									
Ø 460 cm	120 cm	17.450 l	172 kg	1/80x60	4m <sup>3</sup> /h	√	15	12	251158
Ø 350 cm	120 cm	10.102 l	146 kg	1/80x60	4m <sup>3</sup> /h	√	15	12	251165
Ø 240 cm	120 cm	4.750 l	126 kg	1/80x60	4m <sup>3</sup> /h	√	15	12	252421

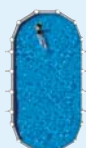

	Medida piscina Pool size cm	Espacio necesario Necessary space cm
<b>KIT730WE</b>	<b>730x375</b>	<b>770x595</b>
<b>KIT610WE</b>	<b>610x375</b>	<b>650x595</b>
<b>KIT500WE</b>	<b>500x300</b>	<b>540x520</b>

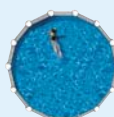

	Medida piscina Pool size cm	Espacio necesario Necessary space cm
<b>KIT460WE</b>	<b>460 ø</b>	<b>500x500</b>
<b>KIT350WE</b>	<b>350 ø</b>	<b>400x400</b>
<b>KIT240WE</b>	<b>240 ø</b>	<b>300x300</b>



- Liner PVC azul 30/100
- Perfilería acero
- Protectores inyección
- PVC blue liner 30/100
- Steel profiles
- Injection saver



PROV503WE

 **KITPROV503WE**



PR453WE

 **KITPR453WE**

 **KITPR353WE**





# serie Madeira



- Filtro cartucho  
- 3,8 m<sup>3</sup>/h
  - Escalera  
- 2x3 Peldaños
- Cartridge filter  
- 3,8 m<sup>3</sup>/h
  - Ladder  
- 2x3 Steps



500x300 cm	120 cm	14.550 l	206 kg	1/80x60	3,8m <sup>3</sup> /h	√	15	12	251103

Ø 460 cm	120 cm	17.450 l	149 kg	3/120x80	3,8m <sup>3</sup> /h	√	15	12	251097
Ø 350 cm	120 cm	10.102 l	109 kg	3/120x80	3,8m <sup>3</sup> /h	√	15	12	251080



<b>KITPROV503WE</b>	<b>Medida piscina</b> Pool size cm <b>500x300</b>	<b>Espacio necesario</b> Necessary space cm <b>540x520</b>
---------------------	--	---

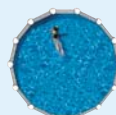

<b>KITPR453WE</b>	<b>Medida piscina</b> Pool size cm <b>460 ø</b>	<b>Espacio necesario</b> Necessary space cm <b>500x500</b>
<b>KITPR353WE</b>	<b>Medida piscina</b> Pool size cm <b>350 ø</b>	<b>Espacio necesario</b> Necessary space cm <b>400x400</b>

# DREAM POOL



- Liner PVC azul 40/100
- Perfilería acero
- Protectores inyección
- PVC blue liner 40/100
- Steel profiles
- Injection saver



PROV9188

**KITPROV10288**

**KITPROV9188**

**KITPROV8188**

**KITPROV7388**

**KITPROV6188**



Sistema de Omegas  
Omega system



PROV918

**KITPROV1028**

**KITPROV918**

**KITPROV818**

**KITPROV738**

**KITPROV618**



PR558

**KITPR558**

**KITPR458**

**KITPR358**



# SERIE HAITI



- Depuradora arena
  - Caudal grupo 10,8,7 e 5m<sup>3</sup>/h
- Escalera de seguridad:
  - Plataforma + 2x3 Peldaños
- Tapiz de suelo
  - Polietileno 115 g/m<sup>2</sup>
- Sand filter
  - Flow group 10,8,7 and 5m<sup>3</sup>/h
- Safety Ladder
  - Platform + 2x3 Steps
- Floor tapestry
  - Polythene 115 g/m<sup>2</sup>



1000x550 cm	132 cm	56.111 l	620 kg	1/120x100	10m <sup>3</sup> /h	√	√	15	12	224626
915x470 cm	132 cm	43.595 l	602 kg	1/120x80	8m <sup>3</sup> /h	√	√	15	12	220215
800x470 cm	132 cm	37.474 l	482 kg	1/120x80	7m <sup>3</sup> /h	√	√	15	12	224633
730x375 cm	132 cm	28.217 l	462 kg	1/120x80	5m <sup>3</sup> /h	√	√	15	12	220222
610x375 cm	132 cm	23.281 l	437 kg	1/90x80	5m <sup>3</sup> /h	√	√	15	12	221328

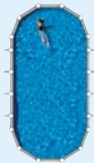

	Medida piscina Pool size cm	Espacio necesario Necessary space cm
<b>KITPROV10288</b>	<b>1000x550</b>	<b>1040x670</b>
<b>KITPROV9188</b>	<b>915x470</b>	<b>955x590</b>
<b>KITPROV8188</b>	<b>800x470</b>	<b>850x590</b>
<b>KITPROV7388</b>	<b>730x375</b>	<b>770x495</b>
<b>KITPROV6188</b>	<b>610x375</b>	<b>650x495</b>

# SERIE ATLANTIS

1000x550 cm	132 cm	56.111 l	498 kg	1/120x80	10m <sup>3</sup> /h	√	√	15	12	220239
915x470 cm	132 cm	43.595 l	480 kg	1/120x80	8m <sup>3</sup> /h	√	√	15	12	211978
800x470 cm	132 cm	37.474 l	428 kg	1/120x80	7m <sup>3</sup> /h	√	√	15	12	211565
730x375 cm	132 cm	28.217 l	335 kg	1/120x80	5m <sup>3</sup> /h	√	√	15	12	211985
610x375 cm	132 cm	23.281 l	270 kg	1/90x80	5m <sup>3</sup> /h	√	√	15	12	211572
Ø 550 cm	132 cm	27.798 l	243 kg	1/90x80	5m <sup>3</sup> /h	√	√	15	12	211589
Ø 460 cm	132 cm	19.444 l	238 kg	1/90x80	5m <sup>3</sup> /h	√	√	15	12	211596
Ø 350 cm	132 cm	11.250 l	184 kg	1/90x80	5m <sup>3</sup> /h	√	√	15	12	233864



	Medida piscina Pool size cm	Espacio necesario Necessary space cm
<b>KITPROV1028</b>	<b>1000x550</b>	<b>1040x770</b>
<b>KITPROV918</b>	<b>915x470</b>	<b>955x690</b>
<b>KITPROV818</b>	<b>800x470</b>	<b>850x690</b>
<b>KITPROV738</b>	<b>730x375</b>	<b>770x595</b>
<b>KITPROV618</b>	<b>610x375</b>	<b>650x595</b>



	Medida piscina Pool size cm	Espacio necesario Necessary space cm
<b>KITPR558</b>	<b>550 ø</b>	<b>600x600</b>
<b>KITPR458</b>	<b>460 ø</b>	<b>500x500</b>
<b>KITPR358</b>	<b>350 ø</b>	<b>400x400</b>





- Liner PVC azul 30/100 (KIT730ECO - KIT610ECO: 40/100)
- Perfilería acero
- Protectores inyección
- PVC blue liner 30/100 (KIT730ECO - KIT610ECO: 40/100)
- Steel profiles
- Injection saver



730ECO

- ◆ KIT730ECO
- ◆ KIT610ECO
- ◆ KIT500ECO



460ECO

- ◆ KIT550ECO
- ◆ KIT460ECO
- ◆ KIT350ECO
- ◆ KIT300ECO
- ◆ KIT240ECO























- Depuradora arena
- Caudal grupo 4 m<sup>3</sup>/h
- Escalera:
- 2x3 Peldaños

- Sand filter
- Flow group 4 m<sup>3</sup>/h
- Ladder
- 2x3 Steps



									
730x375 cm	120 cm	25.323 l	287 kg	1/90x80	4m <sup>3</sup> /h	✓	15	12	252414
610x375 cm	120 cm	20.893 l	234 kg	1/80x60	4m <sup>3</sup> /h	✓	15	12	252407
500x300 cm	120 cm	14.550 l	224 kg	1/80x60	4m <sup>3</sup> /h	✓	15	12	241166

									
Ø 550 cm	120 cm	24.944 l	209 kg	1/80x60	4m <sup>3</sup> /h	✓	15	12	252391
Ø 460 cm	120 cm	17.450 l	172 kg	1/80x60	4m <sup>3</sup> /h	✓	15	12	241159
Ø 350 cm	120 cm	10.102 l	146 kg	1/80x60	4m <sup>3</sup> /h	✓	15	12	241142
Ø 300 cm	120 cm	7.418 l	136 kg	1/80x60	4m <sup>3</sup> /h	✓	15	12	241135
Ø 240 cm	120 cm	4.750 l	120 kg	1/80x60	4m <sup>3</sup> /h	✓	15	12	252384



	Medida piscina Pool size cm	Espacio necesario Necessary space cm
KIT730EEOE	730x375	770x595
KIT610EEOE	610x375	650x595
KIT500EEOE	500x300	540x520



	Medida piscina Pool size cm	Espacio necesario Necessary space cm
KIT550EEOE	550 ø	600x600
KIT460EEOE	460 ø	500x500
KIT350EEOE	350 ø	400x400
KIT300EEOE	300 ø	350x350
KIT240EEOE	240 ø	300x300

# DREAM POOL



- Liner PVC azul 40/100
- Perfilería acero
- Protectores inyección
- PVC blue liner 40/100
- Steel profiles
- Injection saver



PROV7070

- KITPROV7070**
- KITPROV6270**
- KITPROV4870**



PROV613E



- Liner PVC azul 30/100 (KITPROV613E Liner PVC azul 40/100)
- PVC blue liner 30/100 (KITPROV613E PVC blue liner 40/100)

- KITPROV613E**
- KITPROV503E**



PR453E

- KITPR453E**
- KITPR353E**
- KITPR303E**





# SERIE VARADERO



- Depuradora arena
- Caudal grupo 4 m<sup>3</sup>/h
- Escalera de seguridad:
- 2x3 Peldaños
- Tapiz de suelo
- Polietileno 115 g/m<sup>2</sup>
- Sand filter
- Flow group 4 m<sup>3</sup>/h
- Safety Ladder
- 2x3 Steps
- Floor tapestry
- Polythene 115 g/m<sup>2</sup>



710x475 cm	120 cm	27.872 l	371 kg	1/90x80	4m <sup>3</sup> /h	√	√	15	12	211626
640x390 cm	120 cm	20.652 l	311 kg	1/90x80	4m <sup>3</sup> /h	√	√	15	12	211633
500x340 cm	120 cm	13.696 l	284 kg	1/90x80	4m <sup>3</sup> /h	√	√	15	12	231921



	Medida piscina Pool size cm	Espacio necesario Necessary space cm
<b>KITPROV7070</b>	<b>710x475</b>	<b>755x510</b>
<b>KITPROV6270</b>	<b>640x390</b>	<b>700x430</b>
<b>KITPROV4870</b>	<b>500x340</b>	<b>540x380</b>

# SERIE CIES

- Filtro cartucho
- 3,8 m<sup>3</sup>/h
- Escalera:
- 2x3 Peldaños
- Cartridge filter
- 3,8 m<sup>3</sup>/h
- Ladder
- 2x3 Steps



610x375 cm	120 cm	20.893 l	210 kg	1/80x60	3,8m <sup>3</sup> /h	√	-	15	12	241128
500x300 cm	120 cm	14.550 l	205 kg	1/80x60	3,8m <sup>3</sup> /h	√	-	15	12	241111
Ø 460 cm	120 cm	17.450 l	149 kg	1/80x40	3,8m <sup>3</sup> /h	√	-	15	12	241104
Ø 350 cm	120 cm	10.102 l	109 kg	1/80x40	3,8m <sup>3</sup> /h	√	-	15	12	241098
Ø 300 cm	120 cm	7.418 l	94 kg	1/80x40	3,8m <sup>3</sup> /h	√	-	15	12	241081



	Medida piscina Pool size cm	Espacio necesario Necessary space cm
<b>KITPROV613E</b>	<b>610x375</b>	<b>650x595</b>
<b>KITPROV503E</b>	<b>500x300</b>	<b>540x520</b>



	Medida piscina Pool size cm	Espacio necesario Necessary space cm
<b>KITPR453E</b>	<b>460 Ø</b>	<b>500x500</b>
<b>KITPR353E</b>	<b>350 Ø</b>	<b>400x400</b>
<b>KITPR303E</b>	<b>300 Ø</b>	<b>350x350</b>

# DREAM POOL



WPR452E

- Liner PVC azul 20/100
- Sistema overlap
- PVC blue liner 20/100
- Overlap system

**KITWPR452E**

**KITWPR352E**

**KITWPR302**

## SAN MARINA®



WPR450E

- Liner PVC azul 30/100
- Sistema overlap
- PVC blue liner 30/100
- Overlap system

**KITWPR450E**

**KITWPR350E**



WPR300

**WPR300**



# SERIE LANZAROTE



- Filtro cartucho: 2 m<sup>3</sup>/h
- Escalera: 2x2 Peldaños
- Cartridge filter: 2 m<sup>3</sup>/h
- Ladder: 2x2 Steps

Icon: Dimensions	Icon: Height	Icon: Filter	Icon: Weight	Icon: Pallet	Icon: Filter	Icon: Ladder	Icon: Filter	Icon: Filter	Icon: Barcode
Ø 450 cm	90 cm	12.717 l	56	8/120x80	2m <sup>3</sup> /h	√	3,5	3,5	241418
Ø 350 cm	90 cm	7.693 l	47	8/120x80	2m <sup>3</sup> /h	√	3,5	3,5	241401
Ø 300 cm	90 cm	6.358 l	44	8/120x80	2m <sup>3</sup> /h	√	3,5	3,5	231044

# serie tenerife



- Filtro cartucho: 2 m<sup>3</sup>/h
- Escalera: 2x2 Peldaños
- Cartridge filter: 2 m<sup>3</sup>/h
- Ladder: 2x2 Steps

Icon: Dimensions	Icon: Height	Icon: Filter	Icon: Weight	Icon: Pallet	Icon: Filter	Icon: Ladder	Icon: Filter	Icon: Filter	Icon: Barcode
Ø 450 cm	90 cm	12.717 l	56	8/120x80	2m <sup>3</sup> /h	√	3,5	3,5	241210
Ø 350 cm	90 cm	7.693 l	47	8/120x80	2m <sup>3</sup> /h	√	3,5	3,5	241203

# SERIE FORMENTERA

Icon: Dimensions	Icon: Height	Icon: Filter	Icon: Weight	Icon: Pallet	Icon: Filter	Icon: Ladder	Icon: Filter	Icon: Filter	Icon: Barcode
Ø 300 cm	62 cm	3.958 l	22	28/120x80	-	-	3,5	3,5	920771



	Medida piscina Pool size cm	Espacio necesario Necessary space cm
KITWPR452E / KITWPR450E	460 ø	500x500
KITWPR352E / KITWPR350E	350 ø	400x400
KITWPR302	300 ø	350x350



	Medida piscina Pool size cm	Espacio necesario Necessary space cm
WPR300	300 ø	350x350



# JET POOL

## PISCINAS DE TUBO DE ACERO

**LINER:** LÁMINA DE P.V.C. DE ALTA RESISTENCIA. SOLDADURA POR ALTA FRECUENCIA. CON DESAGÜE.  
**ESTRUCTURA:** METÁLICA PINTADA EN EPOXY-POLIESTER ATÓXICO - PARA MAYOR RESISTENCIA A LA CORROSIÓN. PATAS SOLDADAS AL CODO QUE EVITAN LA ROTURA. BASES DE P.V.C. QUE MEJORAN LA ESTABILIDAD DE LA PISCINA.

## STEEL FRAME POOL

**LINER:** HIGH RESISTANCE PVC PLATE. HIGH-FREQUENCY WELDING. DRAIN INCLUDED.  
**STRUCTURE:** NON TOXIC EPOXY-POLYESTER PAINT FOR HIGHER CORROSION RESISTANCE. LEGS WELDED TO ELBOW BENDS TO PREVENT BREAKS. P.V.C. BOTTOMED LEGS FOR INCREASED POOL STABILITY.





# Junior



- Estructura tubular
- Desagüe
- Tubular structure
- Drain









WET230



WET200

JET POOL

							
<b>WET230</b>	Ø 215 cm	45 cm	1.215 l	8,5	60/120x80	√	920238
<b>Y28</b>	Ø 160 cm	40 cm	600 l	6	60/120x80	√	870151
<b>WET200</b>	190x190 cm	45 cm	1.450 l	10,3	60/120x80	√	920221
<b>Y25</b>	125x125 cm	35 cm	500 l	5,7	60/120x80	√	870199







# Complementos Complements

	Página Page	
Cubiertas isotérmicas	38	Isothermic covers
Cubiertas de invierno	39	Winter covers
Mantas	40	Bottom protective blankets
Liners	41	Liners
Escaleras para piscinas enterradas	42	Inground pool ladders
Escaleras para piscinas sobre suelo	43	Above-ground pool ladders
Monoblocs de filtración	44	Filtration kit
Filtro de arena	46	Sand filter
Cargas filtrantes		Filter media
Local técnico		Technical room
Skimmers	47	Skimmers
Filtros de cartucho	48	Cartridge filter
Cartuchos		Cartridges
Bombas	49	Pumps
Tratamiento de agua	50	Water treatment
Electrolisis de sal		Electrolysis of salt
Sistemas de desinfección y dosificación	51	Disinfection and dosing systems
Calefacción	52	Heating systems
Calefacción solar	53	Solar heating system
Material eléctrico	54	Electrical equipment
Iluminación		Lighting
Duchas	56	Showers
Enrolladores de cubiertas	59	Telescopic cover rollers
Repuestos	60	Spare parts

## Leyenda Legend

<b>BX</b>	caja / box
<b>BXL</b>	caja con etiqueta / box and label
<b>CB</b>	cartoncillo / cardboard wrap
<b>CBX</b>	caja litografiada / colour box
<b>PB</b>	bolsa de plástico / polybag
<b>PBH</b>	bolsa de plástico con cartoncillo / polybag with header
<b>BL</b>	blister
<b>CS</b>	doble burbuja / clamshell
<b>DIS</b>	display

## Cubiertas isotérmicas Isothermic covers

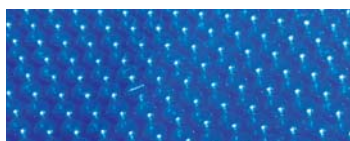

Material: Polietileno  
Material: Polythene



Spessore  
Thick



	cm cm	micrones microns						unid./caja units/box	código code
<b>CPROV8530</b>	754x300	180 μ	850x366	-	-	-	-	<b>PBH pack 1</b>	214535
<b>CPROV7320</b>	632x300	180 μ	730x366	-	-	-	-	<b>PBH pack 1</b>	214542
<b>CPROV6100</b>	511x300	180 μ	610x366	-	-	-	-	<b>PBH pack 1</b>	214559
<b>CPROV5490</b>	470x264	180 μ	550x305	-	-	-	-	<b>PBH pack 1</b>	214566
<b>CPROV700</b>	672x445	180 μ	-	-	710x475	-	-	<b>PBH pack 1</b>	205830
<b>CPROV600</b>	620x370	180 μ	-	-	640x390	-	-	<b>PBH pack 1</b>	205847
<b>CPROV500</b>	472x305	180 μ	-	-	500x340	-	-	<b>PBH pack 1</b>	205854
<b>CPROV1020</b>	995x545	180 μ	-	1000x550	-	-	-	<b>PBH pack 1</b>	220536
<b>CPROV915</b>	910x460	180 μ	-	915x470	-	-	-	<b>PBH pack 1</b>	980324
<b>CPROV810</b>	805x460	180 μ	-	810x470	-	-	-	<b>PBH pack 1</b>	205984
<b>CPROV730</b>	725x370	180 μ	-	730x375	-	-	-	<b>PBH pack 1</b>	980331
<b>CPROV610</b>	605x370	180 μ	-	610x375	-	-	-	<b>PBH pack 1</b>	205991
<b>CPROV505</b>	495x295	180 μ	-	500x300	-	-	-	<b>PBH pack 1</b>	221823
<b>CPR650</b>	640 ø	180 μ	-	-	-	ø 640	-	<b>PBH pack 1</b>	950303
<b>CPR550</b>	545 ø	180 μ	-	-	-	ø 550	-	<b>PBH pack 1</b>	940601
<b>CV450</b>	455 ø	180 μ	ø 550	-	-	ø 460	ø 450 ø 460	<b>PBH pack 1</b>	202525
<b>CV420</b>	415 ø	180 μ	ø 488	-	-	-	-	<b>PBH pack 1</b>	220543
<b>CPR400</b>	395 ø	180 μ	-	-	-	-	ø 400	<b>PBH pack 1</b>	940625
<b>CV375</b>	370 ø	180 μ	ø 457	-	-	-	-	<b>PBH pack 1</b>	220550
<b>CV350</b>	345 ø	180 μ	ø 450	-	-	ø 350	ø 350	<b>PBH pack 1</b>	202532
<b>CV300</b>	295 ø	180 μ	ø 350	-	-	ø 300	ø 300	<b>PBH pack 1</b>	202549
<b>CV250</b>	245 ø	180 μ	ø 300	-	-	ø 240	-	<b>PBH pack 1</b>	208565



## Cubiertas de invierno Winter covers



Material: Polietileno  
Material: Polythene

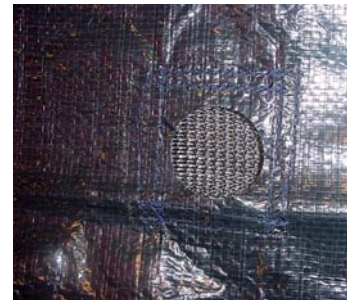

cm  
cm

unid./caja  
units/box

código  
code

	cm	cm									
<b>CIPROV1001</b>	1115x660	100 g/m <sup>2</sup>	-	-	1000x550	-	-	-	-	<b>CBX pack 3</b>	221854
<b>CIPROV911</b>	1030x560	100 g/m <sup>2</sup>	-	-	915x470	-	-	-	-	<b>CBX pack 3</b>	208671
<b>CIPROV821</b>	930x560	100 g/m <sup>2</sup>	-	-	800x470	710x475	-	-	-	<b>CBX pack 3</b>	208688
<b>CIPROV731</b>	820x460	100 g/m <sup>2</sup>	-	-	730x375	640x390	-	-	-	<b>CBX pack 3</b>	208695
<b>CIPROV611</b>	680x460	100 g/m <sup>2</sup>	-	-	610x375	500x340	-	-	-	<b>CBX pack 3</b>	208701
<b>CIPROV501</b>	610x410	100 g/m <sup>2</sup>	-	-	500x300	-	-	-	-	<b>CBX pack 3</b>	221861
<b>CIPR651</b>	730 ø	100 g/m <sup>2</sup>	-	-	-	-	ø 640	-	-	<b>CBX pack 3</b>	208718
<b>CIPR551</b>	640 ø	100 g/m <sup>2</sup>	-	-	-	-	ø 550	-	-	<b>CBX pack 5</b>	208725
<b>CIPR451</b>	540 ø	100 g/m <sup>2</sup>	-	ø 550	-	-	ø 460	ø 450	-	<b>CBX pack 5</b>	208732
								ø 460			
<b>CIPR401</b>	480 ø	100 g/m <sup>2</sup>	ø 440	ø 450	-	-	-	ø 400	-	<b>CBX pack 5</b>	208749
<b>CIPR351</b>	440 ø	100 g/m <sup>2</sup>	ø 360	ø 350	-	-	ø 350	ø 350	-	<b>CBX pack 5</b>	208756
				ø 360							
<b>CIPR301</b>	380 ø	100 g/m <sup>2</sup>	-	-	-	-	ø 300	-	-	<b>CBX pack 5</b>	220567
<b>CIPR241</b>	330 ø	100 g/m <sup>2</sup>	-	-	-	-	ø 240	-	-	<b>CBX pack 5</b>	220574



## Mantas protectoras Bottom protective blanket



Material: Poliéster  
Material: Polyester



Calidad  
Quality



cm  
cm

unid./caja  
units/box

código  
code

<b>MPROV1100</b>	1100x600	110 g/m <sup>2</sup>	-	-	-	1000x550	-	-	-	<b>PBH pack 1</b>	214528
<b>MPROV915</b>	950x500	110 g/m <sup>2</sup>	-	-	-	915x470	-	-	-	<b>PBH pack 1</b>	980256
<b>MPROV810</b>	825x500	110 g/m <sup>2</sup>	780x400	-	-	810x470	710x475	-	-	<b>PBH pack 1</b>	206004
<b>MPROV730</b>	750x400	110 g/m <sup>2</sup>	660x280	-	-	730x375	640x390	-	-	<b>PBH pack 1</b>	980263
<b>MPROV610</b>	625x400	110 g/m <sup>2</sup>	530x280	-	-	610x375	500x340	-	-	<b>PBH pack 1</b>	206011
<b>MPROV500</b>	525x325	110 g/m <sup>2</sup>	-	-	-	500x300	-	-	-	<b>PBH pack 1</b>	231075
<b>MPR650</b>	650x650	110 g/m <sup>2</sup>	-	-	-	-	-	ø 640	-	<b>PBH pack 1</b>	960111
<b>MPR550</b>	550x550	110 g/m <sup>2</sup>	-	-	ø 550	-	-	ø 550	-	<b>PBH pack 1</b>	960128
<b>MPR450</b>	550x500	110 g/m <sup>2</sup>	-	ø 440	ø 450	-	-	ø 460 ø 450	ø 460	<b>PBH pack 1</b>	960135
<b>MPR400</b>	400x400	110 g/m <sup>2</sup>	-	ø 360	-	-	-	ø 350	ø 400	<b>PBH pack 1</b>	960142
<b>MPR350</b>	500x500	110 g/m <sup>2</sup>	-	-	ø 350	-	-	ø 350 ø 300	ø 350	<b>PBH pack 1</b>	960159
<b>MPR250</b>	250x250	110 g/m <sup>2</sup>	-	-	ø 240	-	-	ø 240	-	<b>PBH pack 1</b>	208572



**Ref. MPF509**  
BX pack 14

Material protector de fondos, 9 piezas de 50 x 50 cm  
Espesor 3,5mm  
Bottom protective material: puzzle shaped 9 pieces  
(size of each piece: 50cm x 50cm) Thickness 3,5mm



252001



## Liners Liners



Liner azul (AZ)  
Blue liner (AZ)



Liner arena (AR)  
Sand liner (AR)



Liner cenefa (CF)  
Frieze liner (CF)



BXL pack 1

Material: PVC Material: PVC



Sistema colgante (SC)  
Hanging system (SC)



Sistema overlap (OV)  
Overlap system (OV)



FPR559	(CF)	(SC)	550	132	50/100	205892
FPR459	(CF)	(SC)	460	132	50/100	205908
FPR359	(CF)	(SC)	350	132	50/100	237572
FPR658	(AZ)	(SC)	640	132	40/100	225135
FPR558	(AZ)	(SC)	550	132	40/100	214504
FPR458	(AZ)	(SC)	460	132	40/100	224121
FPR358	(AZ)	(SC)	350	132	40/100	233918
FPR558W	(AR)	(SC)	550	132	40/100	228914
FPR458W	(AR)	(SC)	460	132	40/100	228921
FPR358W	(AR)	(SC)	350	132	40/100	234823
FPR460W	(AR)	(OV)	460	120	30/100	229126
FPR350W	(AR)	(OV)	350	120	30/100	229133
FPR240W	(AR)	(OV)	240	120	30/100	233369
FPR651	(AZ)	(SC)	640	120	40/100	980478
FPR551	(AZ)	(SC)	550	120	40/100	950648
FPR451	(AZ)	(SC)	460	120	40/100	980485
FPR352	(AZ)	(SC)	350	120	40/100	200576
FPR301	(AZ)	(SC)	300	120	40/100	216027
FPR241	(AZ)	(SC)	240	120	40/100	203010
FPR454	(AZ)	(SC)	460	90	30/100	201160
FPR354	(AZ)	(SC)	350	90	30/100	201177
FSP450	(AZ)	(OV)	450	90	20/100	990217
FSP400	(AZ)	(OV)	400	90	20/100	990224
FSP350	(AZ)	(OV)	350	90	20/100	990231
FSP300	(AZ)	(OV)	300	90	20/100	203249
FWPR 30	(AZ)	(OV)	300	65	20/100	201191



FPROV919	(CF)	(SC)	915x470	132	50/100	205861
FPROV819	(CF)	(SC)	810x470	132	50/100	216041
FPROV739	(CF)	(SC)	730x375	132	50/100	205878
FPROV619	(CF)	(SC)	610x375	132	50/100	216034
FPROV918W	(AR)	(SC)	915x470	132	40/100	228884
FPROV738W	(AR)	(SC)	730x375	132	40/100	228891
FPROV618W	(AR)	(SC)	610x375	132	40/100	228907
FPROV730W	(AR)	(OV)	730x375	120	40/100	237886
FPROV610W	(AR)	(OV)	610x375	120	40/100	235158
FPROV500W	(AR)	(OV)	500x300	120	30/100	235165
FPROV1028	(AZ)	(SC)	1000x550	132	40/100	224169
FPROV918	(AZ)	(SC)	915x470	132	40/100	214511
FPROV818	(AZ)	(SC)	810x470	132	40/100	224091
FPROV738	(AZ)	(SC)	730x375	132	40/100	224107
FPROV618	(AZ)	(SC)	610x375	132	40/100	224114
FPROV707	(AZ)	(SC)	700x450	120	40/100	204338
FPROV627	(AZ)	(SC)	625x375	120	40/100	204345
FPROV507	(AZ)	(SC)	500x310	120	40/100	204352
FPROV915	(AZ)	(SC)	915x470	120	40/100	980270
FPROV810	(AZ)	(SC)	810x470	120	40/100	206059
FPROV730	(AZ)	(SC)	730x375	120	40/100	980287
FPROV610	(AZ)	(SC)	610x375	120	40/100	206066
FPROV500	(AZ)	(SC)	500x300	120	40/100	221878

## Escaleras para piscina enterrada Inground pool ladders



**Ref. 40272**  
BX pack 1



250762

Escalera STANDARD para piscina enterrada de 4 peldaños Inox  
Stainless steel STANDARD inground pool ladder - 4 steps



**Ref. 40110**  
BX pack 1



401107

Escalera STANDARD para piscina enterrada de 3 peldaños Inox  
Stainless steel STANDARD inground pool ladder - 3 steps



**Ref. 40274**  
BX pack 1



250779

Escalera MURO para piscina enterrada de 4 peldaños - Inox  
Stainless steel inground pool WALL ladder - 4 steps



**Ref. 40273**  
BX pack 1



250786

Escalera MURO para piscina enterrada de 3 peldaños - Inox  
Stainless steel inground pool WALL ladder - 3 steps





## Escaleras para piscina sobre tierra Above-ground pool ladders



**Ref. AR11680**  
BXL pack 1



231082

Escalera de acero inoxidable  
142cm 2x4 peldaños +  
plataforma  
Stainless steel ladder 142cm  
2x4 steps + platform



**Ref. ES1150**  
BXL pack 1



233765

Escalera de seguridad 134cm  
2x3 peldaños + plataforma  
Safety ladder 134cm  
2x3 steps + platform



**Ref. ES1100**  
BXL pack 1



233772

Escalera de seguridad 120cm  
2x3 peldaños  
Safety ladder 120cm  
2x3 steps



**Ref. ET1200**  
BXL pack 1



242422

Escalera tipo tijera 120cm  
2x3 peldaños  
Ladder 120cm  
2x3 steps



**Ref. AR109**  
BXL pack 1



980522

Escalera tipo tijera 98cm  
2x2 peldaños  
Ladder 98cm  
2x2 steps

## Monoblocs de filtración Filtration kit

Las impurezas quedan retenidas en la arena de sílex (filtro) en el interior de la cuba. Son muy compactos, fáciles de instalar, utilizar y no requieren especial atención. Incorporan un prefiltro para retener las partículas excesivamente grandes y evitar dañar la bomba (\*). Gracias a su válvula selectora (5/6/7 vías dependiendo del modelo), permiten realizar diferentes funciones: autolimpiado, filtración, vaciado... Los filtros FA6100 / FA6080 / FA6070 / FA6050 / FA6040 / FA6030 están certificados con la **norma francesa NF P 90-318** que garantiza que cumplen con las normativas de seguridad establecidas.

Impurities are held by the siliceous sand (filter) inside the tank. Sand filters are compact sized, easy to install and use and special care is not required. They include a prefilter to hold the largest particles to prevent pump from any damage (\*). Thanks to their multiport valves (5/6 ways depending on the version), different functions can be carried out: self-cleaning, filtration, emptying... Filters FA6100 / FA6080 / FA6070 / FA6050 / FA6040 / FA6030 are certified with the **standard French NF P 90-318** ensuring that they comply with the safety regulations set.



Ref. **FA6100**  
BXL pack 1



233857



Ref. **FA6080**  
BXL pack 1



233840



Ref. **FA6070**  
BXL pack 1



233833



Ref. **FA6050**  
BXL pack 1



233826



Ref. **FA6040**  
BXL pack 1



233819



Ref. **FA6030**  
BXL pack 1



233802



w

hp



Ref. Ref.	Diámetro Diameter	Caudal grupo Group flow	Potencia bomba Pump power	Carga de arena (no incluida) Sand (not included)	Vías Ports	Código Code	
<b>FA6100</b>	Ø 600 mm	10.000 l/h	485 W	0,66 CV/HP	±130 kg	6	233857
<b>FA6080</b>	Ø 500 mm	8.000 l/h	630 W	0,86 CV/HP	±90 kg	6	233840
<b>FA6070</b>	Ø 430 mm	7.000 l/h	230 W	0,31 CV/HP	±68 kg	6	233833
<b>FA6050</b>	Ø 380 mm	5.000 l/h	180 W	0,24 CV/HP	±46 kg	5	233826
<b>FA6040</b>	Ø 380 mm	4.000 l/h	125 W	0,17 CV/HP	±46 kg	5	233819
<b>FA6030</b>	Ø 300 mm	3.000 l/h	125 W	0,17 CV/HP	±23 kg	5	233802



**Ref. FAE380T**  
BXL pack 1  
Con temporizador  
With timer



250908



**Ref. FAE380**  
BXL pack 1



238043



**Ref. FAE300**  
BXL pack 1  
\*Sin prefiltro  
\*Without prefilter



238036



Ref. Ref.	Diámetro Diameter	Caudal de grupo Group flow	Potencia de la bomba Pump power	Carga arena (no incluida) Sand (not included)	Vías Ports	Código Code
<b>FAE500</b>	Ø 500 mm	8.500 l/h	550 W	±90 kg	7	250892
<b>FAE380T</b>	Ø 368 mm	6.500 l/h	450 W	±35 kg	7	250908
<b>FAE380</b>	Ø 368 mm	6.500 l/h	450 W	±35 kg	7	238043
<b>FAE300</b>	Ø 320 mm	4.000 l/h	200 W	±20 kg	6	238036



## Filtros de arena Sand filters



Ref. 40175  
BX pack 1



401756



Ref. 40174  
BX pack 1



401749



Ref. 40173  
BX pack 1



401732



Ref. Ref.	Diámetro Diameter	Caudal Flow	Carga arena (no incluida) Sand (not included)	Vías Ports	Código Code
40175	Ø600 mm - Side	14.000 l/h	±100 kg	6	401756
40174	Ø500 mm - Side	9.000 l/h	±75 kg	6	401749
40173	Ø400 mm - Side	6.000 l/h	±50 kg	6	401732

## Cargas filtrantes Filter media



Ref. AR200  
pack 1 pallet 40

Arena - Silex 25kg -  
Granulometría 0,4-0,8  
Sand - Silex 25 kg -  
Grain size 0,4-08



960180



Ref. 90365  
pack 1 pallet 40

Sal compacta  
saco 25kg  
Compact salt  
bag 25kg



903656



Ref. VF025  
pack 1 pallet 50

Vidrio filtrante saco 25kg -  
Granulometría 0,5 - 1 mm  
Glass filter media 25 kg  
Grain size 0,5 - 1 mm



240848



## Local técnico Technical room

Ref. ARNP30  
BXL pack 1



227672

Local técnico fabricado en madera de pino nórdico, tratamiento nivel IV clase V. Con apertura frontal y superior. Incluye troquelado para conexiones. De fácil montaje (se sirve desmontado). Medidas int.: 107x73x91 cm. No incluye filtro.  
Technical room made of nordic pine wood with level IV class V treatment. Upper and front opening. Connection holes included. Easy to assemble (served dismantled). Inside measurements: 107x73x91 cm. Filtration equipment not included.



## Skimmer Skimmer



**Ref. AR100**  
BXL pack 1

Skimmer + boquilla de impulsión  
Skimmer + return fitting



950396

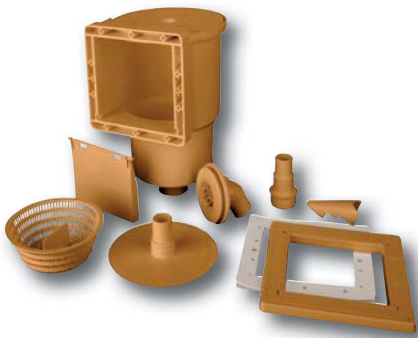
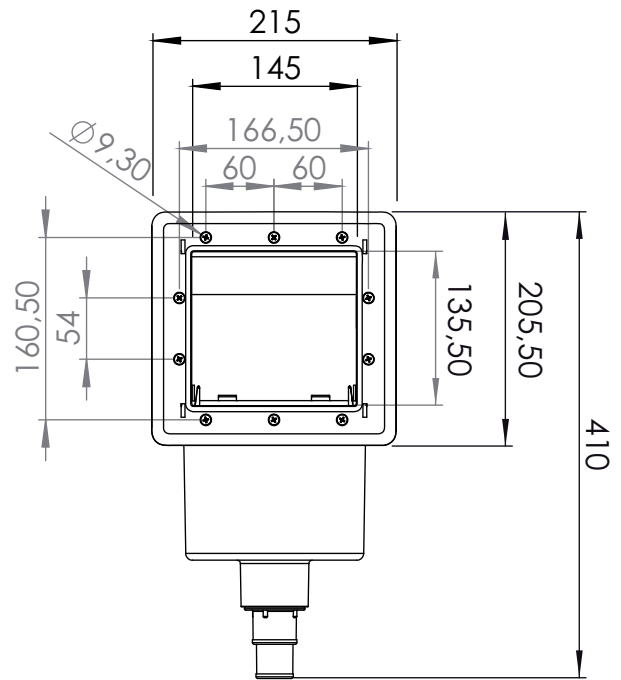

**Ref. AR100W**  
BXL pack 1

Skimmer + boquilla de impulsión  
Skimmer + return fitting



233192



**Ref. SK15H**  
BXL pack 1

Skimmer para piscina enterrada boca estrecha para hormigón  
Narrow mouth skimmer for concrete inground pool



250724



**Ref. SK15L**  
BXL pack 1

Skimmer para piscina enterrada boca estrecha para liner  
Narrow mouth skimmer for liner inground pool



250731

## Filtros de cartucho Cartridge filter

Están especialmente concebidos para piscinas con un volumen de agua medio-inferior. Son muy sencillos de utilizar y su mantenimiento se limita a la limpieza o sustitución del cartucho o filtro de recambio, cuando éste ha quedado obstruido por la excesiva carga de suciedad.

Specially designed for medium-low water volume pools. Cartridge filters are very easy to use and their maintenance is limited to the cartridge cleaning or replacement when dirt is blocking it.



Ref. Ref.	Caudal Flow	Potencia Power	Cartucho Cartridge	Código Code
<b>AR125</b>	3.800 l/h	70W	AR82	970318
<b>AR124</b>	3.800 l/h	70W	AR82	203164
<b>AR121E</b>	2.000 l/h	72W	AR86	210193



**Ref. AR124**  
**Ref. AR121E**  
BXL pack 1



203164  
210193



**Ref. AR125**  
BXL pack 1



970318

## Cartucho Cartridges



**Ref. AR79**



241708

Cartucho tipo A piscina autoportante  
Type A Cartridge inflatable pool



**Ref. AR86**



203409

Cartucho  
Cartridge



Ref. Ref.	Modelo Model	Código Code
<b>AR86</b>	CS pack 12 AR 121/118	203409
<b>AR82</b>	CS pack 12 AR125/124/118	970325
<b>AR89</b>	CS pack 12 AR11806	217017
<b>AR79</b>	PB pack 18 Type A	241708



**Ref. 90182**  
CBX pack 24



901829

Limpiador de cartucho de filtro  
Filter cartridge cleaner





## Bomba Pumps

Gama de bombas autoaspirantes GRE con potencias comprendidas entre 1/3 CV y 2 CV. Se trata de bombas centrífugas de una sola etapa, autocebantes, concebidas para uso con un sistema de filtración de piscina.

The self-priming pump range GRE emits power between 1/3 CV and 2 CV. Centrifugal pumps are single stage, self-priming pumps designed for use in a swimming pool filtration systems.



**Ref. PVV150**  
CBX pack 1

Bomba de velocidad variable. Potencia entre 0,75CV y 1,5CV  
Para todo tipo de piscinas. Control touch. 4 velocidades preprogramadas  
Variable speed pump between 0,75 HP and 1,5 HP.  
All types of pools. Touch control. 4 pre-programmed speeds.



Curvas de rendimiento hidráulico  
Hydraulic performance curves

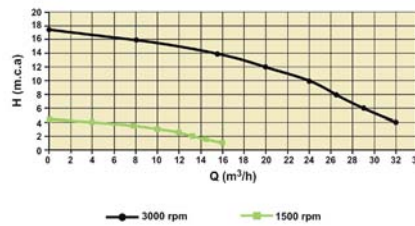

**Ref. CCBDV**  
CBX pack 1



250946

Armario de maniobra para bomba de 2 velocidades PVV150  
Electrical cabinet/programmer for ref. PVV150



**Ref. PP200**  
CBX pack 1

**Ref. PP150**  
CBX pack 1

**Ref. PP100**  
CBX pack 1

Curvas de rendimiento hidráulico Hydraulic performance curves

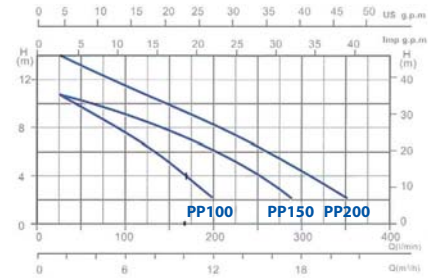

**Ref. PP075**  
CBX pack 1

**Ref. PP050**  
CBX pack 1

**Ref. PP030**  
CBX pack 1

Curvas de rendimiento hidráulico Hydraulic performance curves

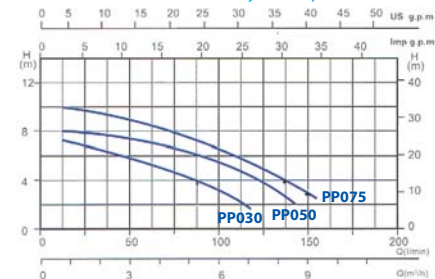

Ref. Ref.	Potencia Power	Potencia Power	Caudal máximo Maximum flow	Volumen máximo Maximum volume	Ø de filtro recomendado Filter recommended Ø	Código Code
<b>PP200</b>	2 CV/HP	1600 w	27 m³/h	170 m³	800 mm	237589
<b>PP150</b>	1,5 CV/HP	1100 w	22 m³/h	135 m³	700 mm	237596
<b>PP100</b>	1 CV/HP	900 w	20 m³/h	100 m³	600 mm	237602
<b>PP075</b>	3/4 CV/HP	450 w	9,5 m³/h	65 m³	500 mm	237619
<b>PP050</b>	1/2 CV/HP	350 w	8,5 m³/h	50 m³	400 mm	237626
<b>PP030</b>	1/3 CV/HP	250 w	7 m³/h	35 m³	300 mm	237633

## Tratamiento de agua Water treatment

### Electrolisis de sal Electrolysis of salt

Los cloradores por electrolisis de sal generan cloro para la desinfección de la piscina a partir de sal. La electrolisis de sal tiene varias ventajas: genera y dosifica automáticamente el cloro en la piscina, evita el almacenamiento y la manipulación de producto químico y es totalmente seguro, ya que sólo utiliza sal común.

Through electrolysis of salt, the chlorinators generate chlorine and salt to disinfect the swimming pool. The electrolysis of salt has various advantages: Generating and automatically dosing the chlorine in the swimming pool, avoids the handling and storage of chemical products and it completely safe, using only sodium chloride.



con controllo PH  
With pH control

**Ref. EES025PH**  
CBX pack 1  
Fino a 25 m<sup>3</sup> - Until 25 m<sup>3</sup>

 250687

**Ref. EES050PH**  
CBX pack 1  
Fino a 50 m<sup>3</sup> - Until 50 m<sup>3</sup>

 250670

**Ref. EES080PH**  
CBX pack 1  
Fino a 80 m<sup>3</sup> - Until 80 m<sup>3</sup>

 250663



**Ref. EES025**  
CBX pack 1  
Fino a 25 m<sup>3</sup> - Until 25 m<sup>3</sup>

 240787

**Ref. EES050**  
CBX pack 1  
Fino a 50 m<sup>3</sup> - Until 50 m<sup>3</sup>

 240794

**Ref. EES080**  
CBX pack 1  
Fino a 80 m<sup>3</sup> - Until 80 m<sup>3</sup>

 240800

**Electrolisis de sal para piscinas enterradas** Generación automática de cloro y dureza del agua. Inversión automática de polaridad. Apta para temperatura de agua superior a 15°C y un pH entre 7,0 y 7,2.  
**Salt chlorinator for in-ground pools** Automatic chlorine and water hardening creation. Automatic polarity reversal. Suitable for water temperatures above 15 °C and a pH reading between 7.0 and 7.2.

DESCRIPCIÓN DESCRIPTION	EES025PH EES025	EES050PH EES050	EES080PH EES080
Tensión de servicio Standard working voltage	230 V AC, 50 Hz./60 Hz.		
Salida (dc) Output (dc)	3.5 A x 2	6 A x 2	3.5 A x 6
Producción (g/h) Production (g/h)	6 - 7	10-12	17-21
Capacidad piscina (m <sup>3</sup> ) Pool volume (m <sup>3</sup> ) Templado: 16-24°C Warm 16-24°C Cálido: +25°C Hot: +25°C	40 25	60 50	100 80
Detector flujo Flow detector	Detector gas Gas detector		
Rango de salinidad/Temperatura Salinity / Temperature range	3 12 g./l. / +15 - 40°C		
Electrodos Electrodes	Titanio con recubrimiento AUTO-LIMPIANTE, calidad ESTANDAR Duración estimada: 3.000-5.000 horas (dependiendo de la calidad del agua) SELF-CLEANING coated Titanium Estimated lifetime: 3.000-5.000 hours of operation (depending on water quality)		
Control producción Production control	0 - 100 % (5 niveles de producción) 0 - 100 % (5 production levels)		
Inversión polaridad Polarity switch	Programmable: 2 <sup>(1)</sup> / 3 horas (jumper en plac de control) + modo test Programmable: 2 <sup>(1)</sup> / 3 hours (jumper in control board) + test mode		
Protección nivel de sal Salt level protection	Protección automática de producción Automatic protection of output current		

<sup>(1)</sup> Configuración fábrica Factory default



### Ref. AR2084 CBX pack 2



212753

#### Clorador de piscina elevadas

Sistema que desinfecta el agua de la piscina convirtiendo por electrolisis el cloruro sódico (sal) en iones de cloro. Fácil instalación. Utilizar solo Cloruro sódico con pureza 99%.

#### Salt chlorinator for above-ground pools

This system disinfects pool water through the electrolysis. It transforms the sodium chloride (salt) into chlorine ions. Easy to install. Use only 99 % pure salt.



## Equipos de desinfección y dosificación Disinfection and dosing systems

Desinfección complementaria al tratamiento químico que proporciona agua fresca, limpia y clara. Permite reducir hasta en un 80% el uso de desinfectantes. Desinfecta el agua de una manera eficaz y segura. Protege su piscina contra los gérmenes patógenos. Fácil instalación y mantenimiento: el agua es iluminada con los rayos ultravioleta por el equipo, impulsada por medio de la bomba del equipo de filtración.

Disinfection product, complementary to chemical treatment, which allows to reduce up to 80% the use of disinfectants which provides fresh, clean and clear water. Disinfects water efficiently and safely. Protects your pool against pathogenic organisms. Easy installation and maintenance: the water is illuminated with UV radiation, driven by the filtration equipment pump.



**Ref. UV015**  
CBX pack 1



250717

**Equipo de desinfección UV para piscinas / spas hasta 15m<sup>3</sup>**  
UV-C Disinfection system (Pools / spas up to 15m<sup>3</sup>)



**Ref. UV045**  
CBX pack 1



250700

**Equipo de desinfección UV para piscinas / spas hasta 50m<sup>3</sup>**  
UV-C Disinfection system (Pools up to 50m<sup>3</sup>)



**Ref. BDP4**  
BXL pack 1



250694

**Bomba dosificadora peristáltica. Caudal variable 4 l/h y 1,5 Bar**  
**Permite dosificar el producto químico de forma fácil y segura**  
Peristaltic dosing pump. Variable flow rate. 4 l/h and 1,5 Bar  
Safe and easy way of dosing of the chemical product



**Ref. AR2000**  
BXL pack 1



221571

**Kit Bypass**  
**Contiene: 3 Válvulas apertura/cierre + 2 mangueras Ø38 mm x 1,5 m + 6 piezas de reducción Ø38 - 50 mm para encolar + 4 abrazaderas**  
Bypass kit  
Contains: 3 opening/closing valves + 2 hoses Ø38 mm x 1,5 m + 6 reduction parts Ø38 - 50 mm to glue + 4 lamps



## Calefacción Heating systems



### Bombas de calor

Sistema energético basado en el aprovechamiento de la energía exterior para calentar el agua de piscina, con relaciones de 1 kw consumido - 5 Kw aportados. Compresor Rotativo (Ref. AR2098 Compresor Scroll) con protección interna, batería evaporadora de alto rendimiento, ventilador axial con motor de acoplamiento directo, condensador de agua de Titanio Puro.

### Heat pumps

Heating system based on the use of the energy coming from the external air to heat pool water in the ratio of 1 Kw of energy consumption to 5 Kw of output. Rotary compressor (Ref. AR2098 Scroll compressor) with internal protection, high performance battery, axial fan with direct coupling motor and Titanium water capacitor.



Ref. AR2098

## Comfort Heat BXL pack 1

Ref.	Volume máximo de piscina Maximum pool volume	Caudal necesario filtración Necessary filtration rate	Potencia termica Heating capacity	Consumo Consumed	Coficiente energético Energy coefficient	Potencia Power	Ruido Noise	Dimensioni Size	Carico Weight	Código Code
AR2094	10.000 l	4.000 l/h	3.000 W	600 W	5	0,5 CV	47 dB	72x35x50 cm	34 kg	224749
AR2095	15.000 l	4.000 l/h	4.200 W	850 W	5	1 CV	47 dB	72x35x50 cm	38 kg	220598
AR2096	30.000 l	5.000 l/h	8.500 W	1.700 W	5	2 CV	51 dB	91x38x65 cm	70 kg	220604
AR2097	47.000 l	7.500 l/h	13.500 W	2.300 W	5	3 CV	58 dB	91x38x65 cm	75 kg	220673
AR2098	72.000 l	9.000 l/h	21.000 W	4.500 W	4,7	5 CV	58 dB	95x34x130 cm	110 kg	227542

Temperatura ambiental de 16°C, temperatura del agua 20°C y humedad del 70%.  
16°C at room temperature, 20°C water temperature and 70% humidity.



### Ref. AR20753

CBX pack 1

### Intercambiador de calor

Sistema diseñado para calentamiento del agua de piscinas o spas. Recomendado principalmente para pequeños volúmenes de agua. Potencia 3 kw. Incorpora termostato, y gracias a su blindaje de titanio, apenas precisa mantenimiento.

### Electrical heat exchanger

System designed to heat pools or spas water. Recommended mainly for small volumes of water. Power output: 3 kw. Thermostat included. Little maintenance required due to its titanium shield.



251806



## Calefacción solar Solar heating system



**Ref. AR2069**

**CBX pack 1**



203331

Sistema para calentamiento del agua de la piscina mediante la acción Solar. Fabricado en polietileno. Aumenta la Temperatura del agua hasta 6°C. Mas de 12 kw/h de calor al día. 600x60 cm. Peso 7 kg. Potencia de la bomba mínima recomendada: 1/3 CV. Solar pool water heating system. Made of polythene. Water temperature can be increased up to 6 °C. 600x60 cm. Wight: 7 kg. Minimum recommended pump output: 1/3 hp.



**Ref. AR20693**

**CBX pack 1**



241449

**Calentador solar de agua para piscinas autoportantes.**

Fabricado con materiales flexibles (nylon y pvc). Medidas: 130x80 cm. Peso 1,2 kg. Aumenta la Temperatura del agua hasta 4°C. Funciona con bomba de piscina desde 4m<sup>3</sup>/h.

**Solar pool water heating system for inflatable pools.**

Made of flexible materials (nylon and pvc). Dimensions: 130x80 cm. Weight: 1,2 kg. Water temperaature can be increased up to 4°C. Minimum water volume: 4m<sup>3</sup>/h.



**Ref. 90230**

**CBX pack 1**



902307

**Calentador solar.** Permite aumentar la temperatura de su piscina por la acción del sol. Los calentadores pueden conectarse entre sí en serie.

**Solar heating.** Solar pool water heating system. The heaters should be connected in series to heat the pool.

## Material eléctrico Electrical equipment

### Iluminación Lighting



7  
colores  
colors

**Ref. LED30**  
BXL pack 2

Lámpara led redonda "LED BALL"  
Batería recargable de litio, con mando a distancia, cambio de colores RGB,  
resistente al agua  
Round LED lamp "LED BALL"  
Rechargeable lithium battery, remote-controlled, RGB color change, waterproof

ø 30 cm ↑ 31 cm



241715



7  
colores  
colors

**Ref. LED21**  
BXL pack 4

Lámpara led forma de gota "LED DECO"  
Batería recargable de litio, con mando a distancia, cambio de colores RGB,  
resistente al agua  
LED teardrop lamp "LED DECO"  
Rechargeable lithium battery, remote-controlled, RGB color change, waterproof

ø 17 cm ↑ 21 cm



241722



**Ref. PLED2**  
CBX pack 4

**Conjunto de 2 proyectores LED para piscina elevada - con mando a distancia**  
Especialmente recomendado para piscinas elevadas de chapa. Fácil instalación,  
se pega a la chapa mediante un imán. Incorpora mando a distancia para fácil  
manejo. Tecnología Led de bajo consumo.  
Set of 2 LED projectors for above ground pools  
Stick to the sheet with a magnet and ready to use. Includes remote control for easy  
operation. Energy-saving LED technology.



250830



**Ref. 90173**  
CBX pack 12

**Lámpara fantasía**  
Los 8 diodos (LED) emisores de luz en colores brillantes crean 7 programas de luz  
diferentes tanto en las paredes como en el fondo de la piscina.  
Fancy lamp  
The 8 light issuing diodes (LED) emit light in bright colours creating 7 different  
lighting programmes for both walls and the floor of the swimming pool.



901737





**Ref. PLBH144**  
BX pack 1



250793

Proyector 144 LEDs blanco piscina enterrada de HORMIGÓN  
Projector with 144 white LEDs for CONCRETE pools

**Ref. PLBL144**  
BX pack 1



250809

Proyector 144 LEDs BLANCO piscina enterrada de LINER  
Projector with 144 white LEDs for LINER pools



**Ref. PLCH144**  
BX pack 1



250816

Proyector 144 LEDs COLOR (RGB) piscina enterrada de HORMIGÓN  
Projector with 144 LEDs, colour RGB for CONCRETE pools



**Ref. PLCL144**  
BX pack 1



250823

Proyector 144 LEDs COLOR (RGB) piscina enterrada de LINER  
Projector with 144 LEDs, colour RGB for LINER pools



**Ref.40710**  
BX pack 12



407109

Bombilla 300w para proyector  
300w bulb for underwater light



**Ref. AR20660**  
CBX pack 1



212067

Foco para piscinas  
Underwater light

## Duchas Showers



**Ref. DSALR32W**  
BXL pack 1



238135

Ducha solar redonda 32l - Aluminio  
Aspecto madera - con grifo lavapies  
Round solar shower 32l - Aluminium  
Woodlike - with footwash tap

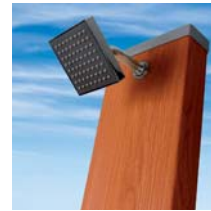

**Ref. DSALC32W**  
BXL pack 1



238142

Ducha solar cuadrada 32l - Aluminio.  
Aspecto madera - con grifo lavapies  
Square solar shower 32l - Aluminium.  
Woodlike - with footwash tap



**Ref. AR1130**  
BXL pack 1



224510

Ducha solar de jardín 32l - Aluminio  
Con nebulizador y grifo lavapies  
Garden solar shower 32l - Aluminium  
Nebulizer and footwash tap

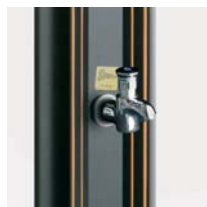

**Ref. AR1035**  
BXL pack 1



230931

Ducha solar 38l - PVC  
Garden solar shower 38l - PVC



**Ref. AR1030**  
BXL pack 1



220765

Ducha solar 30l - PVC  
Garden solar shower 30l - PVC



**Ref. AR10250**  
BXL pack 1



224497

Ducha solar 20l - PVC  
Garden solar shower 20l - PVC



**Ref. AR1020P**  
BXL pack 1



240817

Ducha solar 20l - PVC  
Garden solar shower 20l - PVC



**Ref. 40664**  
CBX pack 1



406645

Ducha solar 20l - PVC  
Color NEGRO  
Garden solar shower 20l - PVC  
BLACK color

**Ref. DS20C**  
CBX pack 1



250854

Ducha solar 20l - PVC  
Color ROJO  
Garden solar shower 20l - PVC  
RED color





**Ref. AR104**  
CBX pack 12

Ducha aluminio  
Aluminium shower



950716



**Ref. LP01**  
PB pack 24

Lavapiés  
Footwash



237695



**Ref. SSB96**  
BXL pack 1

Base para ducha solar  
90 x 60 cm  
Marco de aluminio, y lamas imitación madera  
Solar shower base  
90x60cm  
Aluminum frame and a wood aspect slat



250861



## Enrolladores de cubiertas Telescopic cover rollers



**Ref. 90170**  
CBX pack 1



901706

### Enrollador piscinas enterradas

Enrollador de cubierta « Grandes Ruedas » para piscinas enterradas. Ofrece un desarrollo máximo de 5,50m. Ideal para piscinas redondas, cuadradas u ovaladas. Contiene tubos redondos en aluminio anodizado, un volante ergonómico con empuñadura giratoria así como un kit para atar la cubierta. Se entrega en una sola caja impresa en color.

### Cover roller for inground pools

« Big Wheels » winder cover for in ground pools. Unfolds to a maximum length of 5.50 m. Suitable for round, square or oval swimming pools. Includes round anodised aluminium tubes, an ergonomic hand wheel with revolving handle as well as a kit to attach it to the cover. It is delivered in a coloured printed box.



**Ref. 40135**  
CBX pack 2



401350

### Enrollador piscinas elevadas

El Enrollador ofrece un desarrollo máximo de 6,5m. Se ata fácilmente a las "playas" de la piscina con 2 placas atornilladas. El uso del enrollador permite una mejor conservación de la cubierta. Su nuevo packaging en una sola caja de color ocupa solo más o menos un metro de largo o alto gracias a la nueva definición del producto en 7 tramos de 1,05m y un octavo de 20cm. "Incluido: Conectores para piscinas tubulares."

### Cover roller for above-ground pools

The Winder unfolds to a maximum length of 6.5 m. It can be easily attached to the "playa" finishing pieces of the pool using 2 bolted plates. The use of the winder enables a better conservation of the cover. Its new packaging in a single coloured box more or less about a metre in height or length, thanks to the new product redesign in 7 1.05 m sections and an eighth measuring 20cm. "Included: Connectors for tubular pools."

## Respuestos Spare parts



**Ref. AR500**  
CS pack 6  206462

Cesto para skimmer  
Basket for skimmer  
Ø ext. 16,2 cm ↓ 5,5 cm  
Ø int. 11 cm



**Ref. AR501**  
CS pack 12  206486

Compuerta para skimmer  
Weir for skimmer  
12 x 14,5 x 2 cm



**Ref. AR502**  
CS pack 12  206493

Junta para skimmer  
Skimmer layer  
ext. 20,5 x 19,5 x 0,5 cm  
int. 14,8 x 13,9 x 0,5 cm



**Ref. AR521**  
CS pack 12  250748

Junto doble skimmer + 2  
juntas de válvula de retorno  
Double seal for skimmer + 2  
seals for return valve  
ext. 20,5 x 19,5 x 0,5 cm  
int. 14,8 x 13,9 x 0,5 cm



**Ref. AR503**  
CS pack 6  206509

Boquilla de impulsión  
Return fitting



**Ref. AR505**  
CS pack 8  208619

Tapa para conexión de  
manguera limpiafondos  
Lid for connecting the vacuum  
hose to the skimmer



**Ref. AR506**  
CS pack 8  208602

Manómetro  
Pressure gauge



**Ref. AR512**  
CS pack 12  221601

Válvula apertura/cierre  
Ø38-Ø32  
Open/close valve Ø38-Ø32



# Complementos Complements



**Ref. AR508**  
CS pack 6  208589

Zuncho universal  
Filter ring



**Ref. AR510**  
CS pack 24  215785

Cintasfón y 4 abrazaderas  
Cintasfón and 4 clamps



**Ref. Y12**  
CS pack 50  940861

2 filtros para limpiafondos  
ventury  
2 filters for ventury bottom  
cleaner



**Ref. Y13**  
CS pack 24  203355

5 filtros skimmer  
5 filter savers



**Ref. 40045**  
DIS 1/4N BL pack 21  400452

10 filtros skimmer  
10 filter savers



**Ref. 40080**  
DIS 1/8 BL pack 24  400803

Kit reparación liner  
Liner repair kit



**Ref. V12**  
BL pack 50  870236

Kit reparación PVC  
PVC repair kit



**Ref. AR202**  
BL pack 96  960203

Film reparador PVC  
PVC repair film

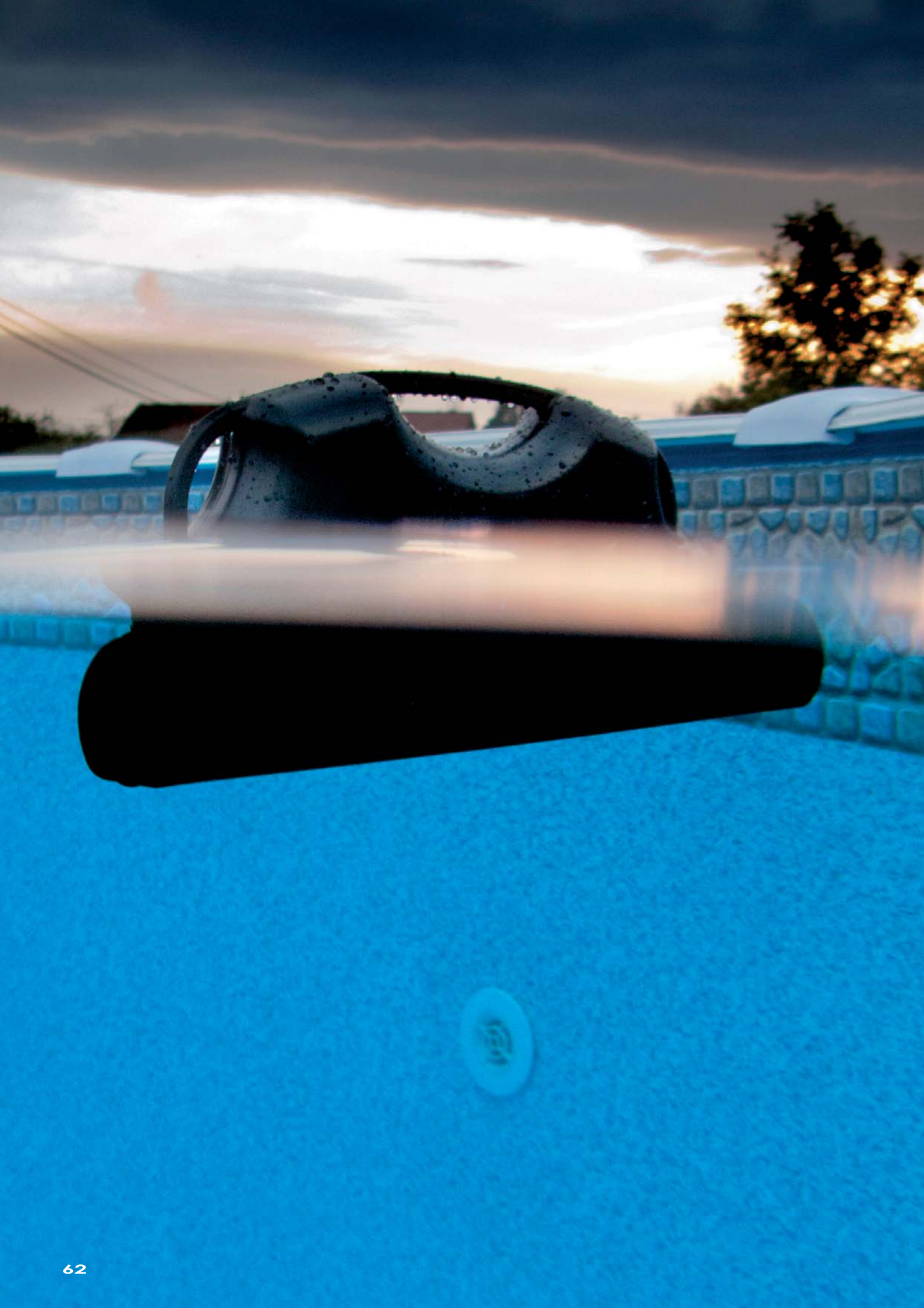

# Material de limpieza Cleaning material

	Page	
Leyenda y Formatos	65	Legend and formats
Robots	66	Robots
Recambios para bolsa filtrante	69	Spare filtration bags
Limpiafondos automáticos	70	Automatic cleaners
Kits limpiafondos de aspiración	72	Vacuum cleaners kits
Limpiafondos Ventury	74	Ventury vacuum
Gama Superluxe	75	Superluxe range
Limpiafondos manuales	76	Vacuum heads
Cepillos	77	Brushes
Dosificadores	78	Dispensers
Termómetros	79	Thermometers
Mangos telescópicos		Telescopic handles
Recogehojas	80	Leaf nets and rakes
Mangueras flotantes	81	Vacuum hoses
Racordería	84	Winter protection
Protección invierno	85	Fittings







## Legenda Legend

- BX** caja / box
- BXL** caja con etiqueta / box and label
- CB** cartoncillo / cardboard wrap
- CBX** caja litografiada / colour box
- PB** bolsa de plástico / polybag
- PBH** bolsa de plástico con cartoncillo / polybag with header
- BL** blister
- CS** doble burbuja / clamshell
- DIS** display



cable / cable



manguera / hose

## Formato Formats

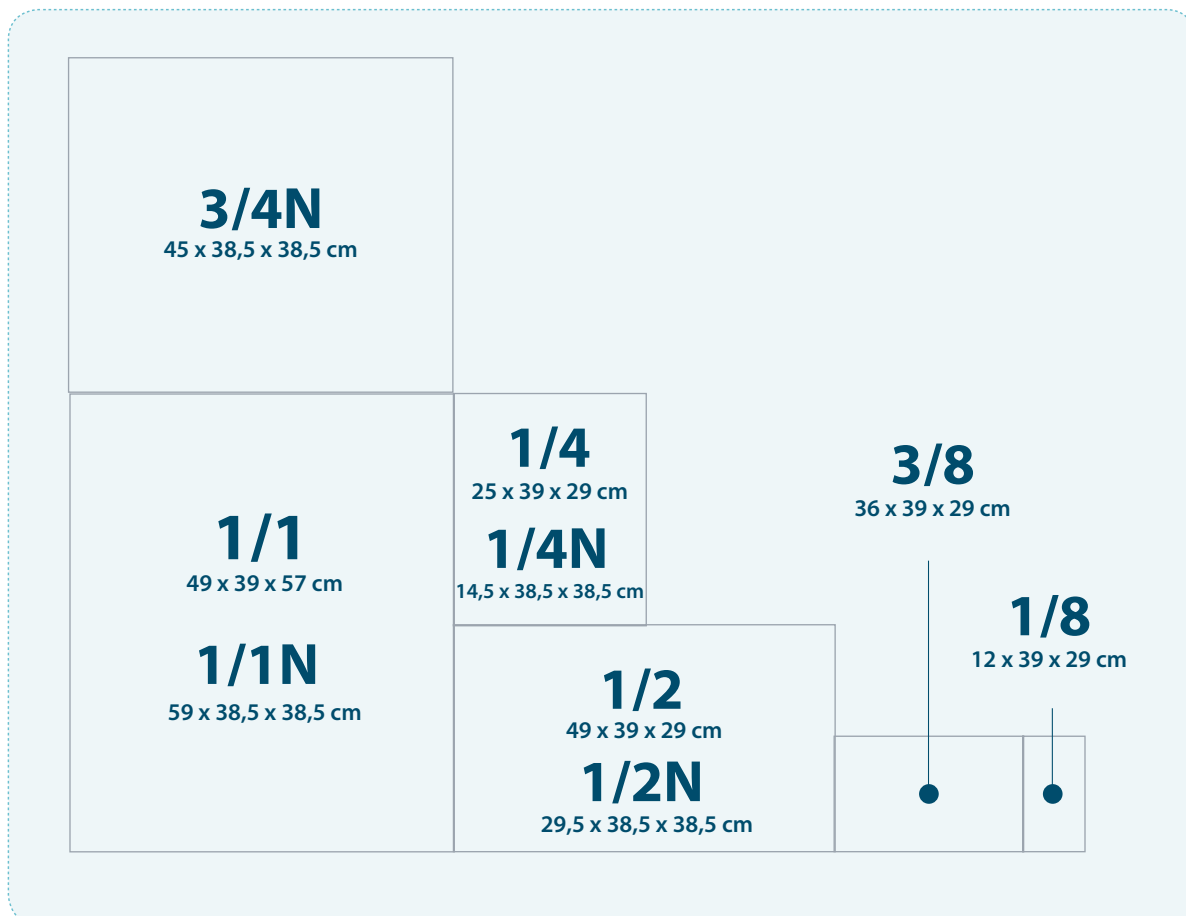

## Robots Robots

Max. 120m<sup>2</sup>



Fondo+Paredes+Linea de agua  
Floor + walls + waterline

TOP ACCESS



Ref. RKFA100CR  
Kayak Future RC Robot con "Aqua Smart" System  
TOP ACCESS

CBX pack 1



18 m



253312

Para piscinas hasta 120m<sup>2</sup>  
Potencia de filtrado: 17m<sup>3</sup>/h  
Cable: 18m  
Motor dirección: 24V

For pools up to 120m<sup>2</sup>  
Filtering power: 17m<sup>3</sup>/h  
Cable: 18m  
Steering motor: 24V

Max. 100m<sup>2</sup>

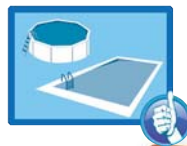

Fondo+Paredes+Linea de agua  
Floor + walls + waterline

TOP ACCESS



Ref. RKFA100  
Kayak Future Robot con "Aqua Smart" System  
TOP ACCESS

CBX pack 1



18 m



250847

Para piscinas hasta 100m<sup>2</sup>  
Potencia de filtrado: 17m<sup>3</sup>/h  
Cable: 18m  
Motor dirección: 24V

For pools up to 100m<sup>2</sup>  
Filtering power: 17m<sup>3</sup>/h  
Cable: 18m  
Steering motor: 24V

El Robot Kayak Future RC RKFA100CR se adapta a todo tipo de piscinas hasta 120m<sup>2</sup> de superficie y limpia el fondo, las paredes y la línea de agua de su piscina.

El Robot Kayak Future RKFA100 se adapta a todo tipo de piscinas hasta 100m<sup>2</sup> de superficie y limpia el fondo, las paredes y la línea de agua de su piscina.

El Aqua Smart System es un software avanzado que permite, mediante un algoritmo, calcular de forma óptima el recorrido que debe hacer el robot para lograr una limpieza de la piscina de forma eficiente y en el menor tiempo posible.

Los robots RKFA100 y RKFA100CR le indican cuando es el momento de limpiar el cartucho filtrante a través del icono "Check Filter", cuya luz se ilumina para recordarle que debe sacar el cartucho, limpiarlo y volver a colocarlo en el robot para que este pueda seguir trabajando eficientemente.

Estos robots cuentan también con la posibilidad de elegir el programa de limpieza que más se adecúe a su piscina: 1,5h o 2h. El robot RKFA100CR además tiene un programa de una hora de duración en el que limpia solamente el fondo de la piscina. También cabe la posibilidad de conectar un timer externo para poder programar la hora a la que quiere que se lleve a cabo la misma.

Los robots RKFA100 y RKFA100CR incorporan la tecnología TOP ACCESS que permite el acceso superior al filtro. Su utilización resulta muy cómoda debido al fácil acceso al filtro de residuos. Este cartucho filtrante es fácil de abrir, limpiar (simplemente colocándolo bajo el chorro del agua) y volver a colocar.

El Robot Kayak Future RC incluye control remoto con mando a distancia.

El Robot Kayak Future y el Kayak Future RC incluyen carrito de transporte, para facilitar su manipulación y almacenamiento.

The Robot Kayak Future RC RKFA100CR adapts to all types of pools measuring up to 120m<sup>2</sup> in surface area, cleaning the bottom, walls and water line.

The Robot Kayak Future RKFA100 adapts to all types of pools measuring up to 100m<sup>2</sup> in surface area, cleaning the bottom, walls and water line.

The Aqua Smart System is advanced software that uses an algorithm to calculate the optimal cleaning path allowing the robot to clean the pool efficiently and in the least amount of time possible.

The RKFA100 and the RKFA100CR indicate when it is necessary to clean the filter cartridge thanks to the "Check Filter" icon that lights up when the cartridge should be removed, cleaned and repositioned in the robot so that it may continue cleaning efficiently.

These robots also allow for the selection of the ideal cleaning program for your pool: 1.5h or 2h. The RKFA100CR in addition has 1 hour program in which cleans only the bottom of the pool. They include the possibility of connecting an external timer in order to program the time when you wish for it to clean.

Both robots Kayak Future and Kayak Future RC with the "Aqua Smart" system incorporate TOP ACCESS technology, offering superior access to the filter. It is very comfortable to use due to its easy waste filter access. The filtering cartridge is easy to open, clean (simply place under running water) and replace. The Robot Kayak Future CR includes a remote control device. Both robots RKFA100CR and RKFA100 include caddy cart for easy handling and storage.



# Material de limpieza Cleaning material



Max. 60m<sup>2</sup>



Fondo plano o inclinado  
Flat or sloping bottom

Ref. RKC100J

Kayak Clever Poolroboter - TOP ACCESS

CBX pack 1



241753

- Para piscinas hasta 60m<sup>2</sup>
- Potencia de filtrado: 18m<sup>3</sup>/h
  - Cable: 12m
- Motor dirección: 24V
- For pools up to: 60m<sup>2</sup>
- Filtering power: 18m<sup>3</sup>/h
  - Cable: 12m
- Steering motor: 24V

El Robot Kayak Clever RKC100J se adapta a todo tipo de piscinas hasta 60m<sup>2</sup> de superficie y limpia el fondo de estas, tanto si es un fondo inclinado como plano. Este robot cuenta con la posibilidad de elegir el programa de limpieza que más se adecúe a su piscina: 1h o 2h

Este robot incorpora la tecnología TOP ACCESS, es decir, permite el acceso superior al filtro. Su utilización resulta muy cómoda debido al fácil acceso al filtro de residuos. Este cartucho filtrante es fácil de abrir, limpiar (simplemente colocándolo bajo el chorro del agua) y volver a colocar.

El Robot Kayak Clever RKC100J, con una potencia de filtrado de 18m<sup>3</sup>/h.

The Robot Kayak Clever RKC100J adapts to all types of pools measuring up to 60m<sup>2</sup> in surface area, cleaning the bottoms whether they are flat or inclined. This robot also allows for the selection of the ideal cleaning program for your pool: 1h or 2h.

This robot incorporates TOP ACCESS technology, offering superior access to the filter. It is very comfortable to use due to its easy access to the waste filter. The filtering cartridge is easy to open, clean (merely place under running water) and replace.

The Robot Kayak Clever RKC100J, with a filtering power of 18m<sup>3</sup>/h, can clean your pool in 2 hours.

Max. 60m<sup>2</sup>



Fondo plano o inclinado  
Flat or sloping bottom

- Para piscinas hasta 60m<sup>2</sup>
- Potencia de filtrado: 18m<sup>3</sup>/h
  - Cable: 12m
- Motor dirección: 24V
- For pools up to: 60m<sup>2</sup>
- Filtering power: 18m<sup>3</sup>/h
  - Cable: 12m
- Steering motor: 24V

Ref. RKJ14

KAYAK JET BLUE

CBX pack 1



252223

El robot KAYAK JET BLUE limpia el fondo de la piscina en un máximo de 2 horas., ya que cuenta con la posibilidad de elegir el programa de limpieza que más se adecúe a su piscina: 1h o 2h.

Funciona independientemente del equipo de filtración a 12v. Capacidad de filtración: 18m<sup>3</sup>/h. Robot autónomo que limpia piscinas de fondo plano o inclinado.

The KAYAK JET BLUE robot cleans the bottom of your pool within 2 hours maximum, allows for the selection of the ideal cleaning program for your pool: 1h or 2h.

Stands alone from the filtering equipment and runs at 12v. Filter capacity: 18m<sup>3</sup>/h. Autonomous robot that cleans flat or sloping bottom surface pools.

Max. 80m<sup>2</sup>



**Fondo+Paredes+Linea de agua**  
Floor + walls + waterline

- Para piscinas hasta 80m<sup>2</sup>
- Potencia de filtrado: 16m<sup>3</sup>/h
  - Cable: 18m
- Motor dirección: 24V
- For pools up to: 80m<sup>2</sup>
- Filtering power: 16m<sup>3</sup>/h
  - Cable: 18m
- Steering motor: 24V

**Ref. R44SP**  
**Robot TRACK 4x4**  
CBX pack 1



252230

El robot TRACK 4x4 es un robot autónomo que limpia el fondo y las paredes de la piscina hasta la línea de flotación. Limpia el fondo de cualquier piscina hasta 80m<sup>2</sup>. El robot TRACK 4x4 limpia la piscina en 3 horas. Capacidad de filtración 16m<sup>3</sup>/h.  
The TRACK 4x4 Robot is an autonomous robot that cleans the bottom and the walls up to the waterline. Suitable for all swimming pool types up to 80m<sup>2</sup>. The TRACK 4x4 Robot cleans your pool within 3 hours. Filter capacity: 16m<sup>3</sup>/h.

Max. 80m<sup>2</sup>



**COBIA**  
(Chlorine On Board  
Integrated Automation)



**Fondo+Paredes+Linea de agua**  
Floor + walls + waterline

- Para piscinas hasta 80m<sup>2</sup>
- Potencia de filtrado: 16m<sup>3</sup>/h
  - Cable: 18m
- Motor dirección: 24V
- For pools up to: 80m<sup>2</sup>
- Filtering power: 16m<sup>3</sup>/h
  - Cable: 18m
- Steering motor: 24V

**Ref. R44SC**  
**Robot TRACK SALT 4x4**  
CBX pack 1



252247

El robot TRACK SALT 4x4 es un robot autónomo que limpia el fondo y las paredes de la piscina hasta la línea de flotación. Recomendado para todo tipo de piscinas hasta 80m<sup>2</sup>. Capacidad de filtración 16m<sup>3</sup>/h. Este robot incorpora un Generador de Cloro que genera automáticamente cloro ecológico para el cuidado y limpieza de la piscina. La producción de cloro (14g/h) es distribuida uniformemente en la piscina. Este sistema permite la producción de cloro a la vez que limpia la piscina. Este robot indica cuando es el momento de limpiar la bolsa filtrante a través del icono "Check Filter", cuya luz se ilumina para recordarle que debe sacar el cartucho, limpiarlo y volver a colocarlo en el robot para que este pueda seguir trabajando eficientemente.

El transformador tiene tres modos de funcionamiento:

1. Sólo limpieza física: en este caso el robot realiza la limpieza de la piscina y se apaga automáticamente.
2. Modo limpieza física y clorador: el robot genera cloro según los parámetros preestablecidos por el usuario en el transformador. A lo largo de estos ciclos el robot se moverá por la piscina para generar cloro en todos los rincones. Cuando el robot se mueva estará realizando a la vez un ciclo de lavado físico.
3. Modo sólo clorador. El robot sólo generará cloro.

TRACK SALT 4x4 is an autonomous robot that cleans the bottom and the walls up to the waterline. Suitable for all swimming pool types up to 80m<sup>2</sup>. Filter capacity: 16m<sup>3</sup>/h.

TRACK SALT 4x4 Robot incorporates a Chlorine Generator that generates automatically ecological chlorine. Chlorine production (14g/h) is uniformly distributed in the pool. This system allows the production of chlorine and the cleaning of the pool simultaneously. This robot indicates when it is necessary to clean the filter cartridge thanks to the "Check Filter" icon that lights up when the cartridge should be removed, cleaned and repositioned in the robot so that it may continue cleaning efficiently.

This robot has 3 user modes:

1. Physical cleaning mode: the robot cleans the pool without generating chlorine.
2. Physical and chemical cleaning mode: the robot cleans the pool and generates chlorine.
3. Chemical cleaning mode: the unit will only generate chlorine.

# Material de limpieza Cleaning material



Max. 80m<sup>2</sup>



**Fondo+Paredes+Linea de agua**  
Floor + walls + waterline

- Para piscinas hasta 80m<sup>2</sup>
- Potencia de filtrado: 17m<sup>3</sup>/h
  - Cable: 18m
- Motor dirección: 24V
- For pools up to: 80m<sup>2</sup>
- Filtering power: 17m<sup>3</sup>/h
  - Cable: 18m
- Steering motor: 24V

**Ref. RKM80CR**  
**Robot KAYAK ADVENTURE MAX**  
CBX pack 1



El KAYAK ADVENTURE es un robot autónomo que limpia el fondo y las paredes de la piscina hasta la línea de flotación. Apto para todo tipo de piscinas hasta 80m<sup>2</sup>. El robot KAYAK ADVENTURE limpia la piscina en 2 horas. Se entrega con carro para su fácil manejo y almacenamiento. Capacidad de filtración: 17m<sup>3</sup>/h. Incluye mando a distancia para manejo por control remoto.  
KAYAK ADVENTURE MAX is an autonomous robot that cleans the bottom and the walls up to the waterline. Suitable for all swimming pool types up to 80m<sup>2</sup>. The KAYAK ADVENTURE MAX cleans your pool within 2 hours. Delivered with its trolley for easy handling and storage. Filter capacity: 17 m<sup>3</sup>/h. Automatic remote controlled.

Max. 80m<sup>2</sup>



**Fondo+Paredes+Linea de agua**  
Floor + walls + waterline

- Para piscinas hasta 80m<sup>2</sup>
- Potencia de filtrado: 17m<sup>3</sup>/h
  - Cable: 18m
- Motor dirección: 24V
- For pools up to: 80m<sup>2</sup>
- Filtering power: 17m<sup>3</sup>/h
  - Cable: 18m
- Steering motor: 24V

**Ref. RKA80**  
**Robot KAYAK ADVENTURE**  
CBX pack 1



El KAYAK ADVENTURE es un robot autónomo que limpia el fondo y las paredes de la piscina hasta la línea de flotación. Apto para todo tipo de piscinas hasta 80m<sup>2</sup>. El robot KAYAK ADVENTURE limpia la piscina en 3 horas. Se entrega con carro para su fácil manejo y almacenamiento. Capacidad de filtración: 17m<sup>3</sup>/h.  
KAYAK ADVENTURE is an autonomous robot that cleans the bottom and the walls up to the waterline. Suitable for all swimming pool types up to 80m<sup>2</sup>. The KAYAK ADVENTURE cleans your pool within 3 hours. Delivered with its trolley for easy handling and storage. Filter capacity: 17 m<sup>3</sup>/h.

## Recambios bolsa filtrante Spare filtration bags



**Ref. 40683**  
PB pack 2



Recambio de bolsa filtrante textil - reutilizable - lavable  
Spare filtration bag for Kayak Robot - 1 unit. Reusable - Washable



**Ref. 40684**  
CBX pack 8



Bolsa para robot desechable - 3 bolsas  
Non-returnable spare filtration bag - 3 units



## Limpiafondos automáticos Automatic cleaners



### Ref. 90397 Silence VAC

CBX pack 2

9,6 m - Ø 38



903977

Limpiafondos automático más silencioso que los sistemas tradicionales de "martillo". Su sistema de membrana le permite garantizar un rendimiento óptimo y más silencioso. Limpia el fondo y las paredes de su piscina. Funciona con sistemas de filtración de una potencia mínima de ½cv y máxima de 1½cv.

Automatic pool cleaner which is quieter than the traditional "hammer" systems. Its membrane system ensures an optimum and quieter performance. The Silence Vac cleans the bottom and walls of your pool. Works with ½ hp minimum and 1½hp maximum power filtration systems.



### Ref. 19001 Classic Vac

CBX pack 1

8 m - Ø 38



190018

Limpiafondos automático para piscinas enterradas y elevadas dotadas de un equipo de filtración con una bomba de una potencia mínima de 3/4 cv. Automatic pool cleaner for in ground and above ground pools equipped with filtering equipment with a minimum power pump of 3/4 hp.



**Ref. 90399 Wiki Vac**

CBX pack 2

6 m - Ø 32



903991

Limpiafondos automático para piscinas autoportantes y elevadas. Funciona con equipos de filtración de baja potencia: a partir de 3m<sup>3</sup>/h (0,1cv). Dispone de un prefiltro exclusivo que permite proteger el cartucho y la filtración aumentando así la vida de los equipos.

The automatic pool cleaner for inflatable or above ground pools. Works with low-power filtering equipment: ranging from 3m<sup>3</sup>/h (0.1hp). It has a unique pre-filter which protects the cartridge and filtration and in this way increasing the operating life of the equipment.



**Ref. AR20682 Small Confort**

CBX pack 4

6 m - Ø 32



232287

Limpiafondos automático por aspiración. Se conecta directamente al skimmer y es compatible con bombas a partir de 1/3CV. Incluye manguera de 6m (en 8 tramos).

Automatic suction pool cleaner that is directly connected to the skimmer. Compatible with pumps from 1/3HP. It includes 6m hose (8 sections).

## Kits limpiafondos de aspiración Vacuum cleaner kits



### Ref. AR20637 Medium Vac

CBX pack 6

9 m - Ø 32



231099

Kit de mantenimiento para piscinas autoportantes o elevadas. Contiene: un limpiafondos de aspiración manual que incluye dos boquillas, una de ellas con cepillo + manguera 9m + pértiga 6 secciones + 3 piezas de conexión

Maintenance kit for inflatable or above ground pools. The pool cleaner includes: two suction nozzles, one with a brush + 9m hose + 6 section pole + 3 connection pieces



### Ref. 08011 Little-VAC

CBX pack 6

5 m - Ø 32



080111

Kit de mantenimiento para piscinas autoportantes o elevadas. Contiene: limpiafondos de aspiración manual + manguera 5m + pértiga 4 secciones + 3 piezas de conexión

Maintenance kit for inflatable or above ground pools. Includes: manual power suction pool cleaner + 5m hose + 4 section pole + 3 connection pieces



### Ref. KMA05

CS pack 6



237664

Kit mantenimiento piscinas: analizador pH/Cl, cepillo 45 cm, recogehojas supercye, termómetro y limpiafondos

Pool maintenance kit: pH/Cl Test kit, 45 cm Brush, leaf net, thermometer and Vacuum head



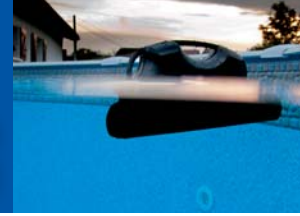

**Ref. AR20641**  
CBX pack 2



224718

Limpiafondos para pértiga + pértiga 3 secciones + recogedor de fondo + termómetro flotante + dosificador oval + cepillo para liner + manguera 6m + bote de tiras reactivas (tester)  
Bottom cleaner for pole + 3 section pole + leaf skimmer of bottom + floating thermometer + oval dispenser + brush for liner + 6m hose + can of reactive test strips (tester)



**Ref. AR2064**  
CBX pack 4



202433

Kit limpiafondos + pértiga 3,60m (3x1,20m) + manguera 6m  
Vacuum head kit + handle 3,60m (3x1,20m) + 6m hose



**Ref. 08050**  
CS pack 6



080500

Kit piscina autoportante: analizador pH/Cl, cepillo, recogehojas de superficie, mango 1,20m (3 tramos) termómetro tubular, dosificador y jet vac ventury  
Special inflatable pool kit: pH/chlorine test kit, brush, leaf net, tubular thermometer, 1,20m handle (3 sections), floating dispenser and ventury vacuum.

## Limpiafondos Ventury Ventury Vacuum



**Ref. PSV51**  
CBX pack 6



250137

Pool & Spa Vac: Limpiafondos manual con 5 accesorios  
Incluye: recogedor superficie, boquilla ancha aspiración, cepillo acoplable,  
soporte para pared  
Pool & Spa Vac:  
Includes: Leaf net+ Suction nozzle+ Attachable brush + Wall bracket

---



**Ref. 90111**  
Bx Pack 10



901119

Limpiafondos Micro-Ventury  
Micro-Ventury Vacuum

---



**Ref. Y15**  
CBX pack 12



201214

Kit limpiafondos Ventury+ pértiga  
Ventury vacuum kit + handle

---



**Ref. Y10**  
CBX pack 6



890180

Limpiafondos Ventury+ pértiga  
Ventury vacuum + handle

---

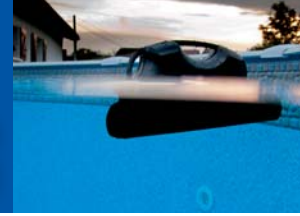

## Gama Superluxe Superluxe range



**Ref. LCBP45**  
CS pack 12

Cepillo Luxe ballena 45 cm para paredes  
45 cm wall whale brush



241760



**Ref. LBP40**  
CB pack 12

Cepillo Luxe de 34 cm con cerdas de plástico  
Luxe brush 34 cm



241777



**Ref. LAMF10**  
CS pack 6

Cabezal Luxe aspirador manual flexible con cepillos  
Flexible Luxe suction pool cleaner with brushes



241784



**Ref. LAMTF10**  
CB pack 6

Cabezal Luxe aspirador manual triangular flexible  
Flexible Luxe triangular suction pool cleaner



241821



**Ref. LRF10**  
CB pack 12

Recogehojas de fondo Luxe con malla de nylon  
Nylon net Luxe leaf rake



241791



**Ref. LRS10**  
CB pack 12

Recogehojas de superficie Luxe con malla de nylon  
Nylon net Luxe leaf net



241807



**Ref. LDCT200**  
PBH pack 12

Dosificador triangular pastillas de 200-250 gr  
Triangular dispenser 200-250 gr tablets



241814



## Limpiafondos manuales Vacuum heads



**Ref. 40022**

**BX** pack 6

Limpiafondos de aluminio  
Aluminium vac head



400223



**Ref. 40016**

**DIS** 1/2N pack 4

Limpiafondos triangular rotativo  
Triangular swivelling vac head



400162



**Ref. 40017**

**DIS** 1/2N pack 6

Limpiafondos ovalado rotativo con cepillos laterales  
Oval swivelling vac head with lateral brushes



400179



**Ref. 40018**

**DIS** 3/4N pack 12

Limpiafondos manual rotativo 8 ruedas con cepillos laterales  
Swivelling vacuum head 8 wheels with lateral brushes



400186



**Ref. 40092**

**DIS** 1/4N pack 20

Empuñadura clip Ø28mm  
Clip handle Ø28mm



400926



## Cepillos Brushes



**Ref. 40046**  
DIS 3/4N pack 12

Cepillo aluminio  
Aluminium brush



400469



**Ref. CAA25**  
DIS 1/2N pack 32

Cepillo aluminio para eliminar algas  
Aluminium brush to eliminate the algae



241456



**Ref. 40802**  
DIS 3/4N pack 10

Cepillo aspirante  
Vacuum brush



408021



**Ref. 40041**  
DIS 3/4N pack 12

Cepillo Gran Formato  
Big Format brush



400414



**Ref. 40040**  
DIS 1/4N pack 12

Cepillo línea de agua  
Waterline brush



400407



**Ref. 40806**  
DIS 1/4N pack 18

Cepillo aspirador limpia-esquinas  
Vacuum corner brush



408069

## Dosificadores Dispensers



**Ref. DCT20**  
DIS 1/2N pack 36

Combi Termo-dosificador: Dosificador pastillas de 20 g + Termómetro  
Combi Thermo-dosifier: Dosifier 20 g tablets + Thermometer



241463



**Ref. 40070**  
DIS 1/2N pack 5

Combi Termo-dosificador: Dosificador Capacidad 1,5 Kg (pastillas de 20 a 500 g) + Termómetro + Visor de consumo de producto  
Combi Thermo-dosifier: Dosifier Capacity 1,5 kg (20 500 g tablets) + Thermometer + Product Consumption Viewer



400704



**Ref. AR7**  
CBX pack 12

Dosificador flotante. 5 pastillas de 200 g  
Floating dispenser. Capacity: 7 tablets 200 g



940892



**Ref. 40071**  
DIS 1/2N pack 30

Dosificador flotante. Capacidad: 7 pastillas de 20 g  
Floating dispenser. Capacity: 7 tablets 20 g



400711

## Termómetros Thermometers



**Ref. 40051**  
DIS 1/2N pack 18

Termómetro tubular flotante  
Tubular floating thermometer



400513



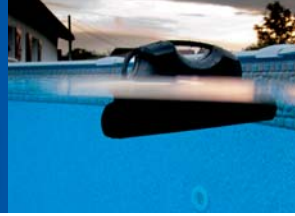

**Ref. 40054**  
DIS 1/2N pack 10

Termómetro boya  
Buoy thermometer



400544



**Ref. 40055**  
CB pack 15

Termómetro bola  
Ball thermometer



400551



**Ref. 40050**  
CS pack 12

Termómetro "Big" - Doble lectura  
"Big" thermometer - double reading



400506

## Mangos telescópicos Telescopic handles



**Ref. 40011**  
BX pack 10

Mango telescópico plateado 4,80m (2x2,40m)  
Telescopic silver handle 4,80m (2 x2,40m)



400117

**Ref. 40010**  
BX pack 10

Mango telescópico plateado 3,60m (2x1,80m)  
Telescopic silver handle 3,60m (2 x1,80m)



400100

**Ref. 40013**  
BX pack 20

Mango telescópico plateado 2,40m (2x1,20m)  
Telescopic silver handle 2,40m (2x1,20m)



400131

## Recogedores Leaf nets and rakes



**Ref. RHFAL**

DIS 1/1N pack 12

Recogehojas fondo aluminio  
Aluminium Leaf rake



237688



**Ref. RHSAL**

DIS 1/1N pack 12

Recogehojas superficie aluminio  
Aluminium Leaf net



237671



**Ref. 40031**

CB pack 12

Recogehojas de superficie + mango telescópico  
Leaf net + telescopic handle



400315



**Ref. 40032**

DIS 1/1 pack 12

Recogehojas de fondo Gran Formato  
Big format Leaf rake



400322



**Ref. 40030**

DIS 1/1 pack 12

Recogehojas de superficie Gran Formato  
Big format Leaf net



400308

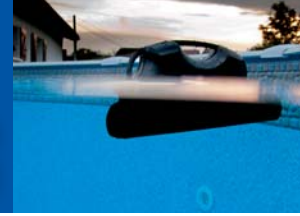

## Mangueras Vacuum hoses



40180

**Ref. 40181**  
BX pack 1

Manguera para filtro 4m - con 2 terminales Ø32mm  
Filter hose 4m - with 2 cuffs Ø32mm



401817

**Ref. 40180**  
BX pack 1

Manguera para filtro 4m - con 2 terminales Ø38mm  
Filter hose 4m - with 2 cuffs Ø38mm



401800



AR210

**Ref. AR212**  
BX pack 1

Manguera limpiafondos 4m con 2 terminales Ø38mm  
Vacuum hose 4m - with 2 cuffs Ø38mm



240824

**Ref. AR210**  
BX pack 1

Manguera limpiafondos 6m con 2 terminales Ø38mm  
Vacuum hose 6m with 2 cuffs Ø38mm



960296

**Ref. 40001**  
BX pack 1

Manguera limpiafondos 8m - con 2 terminales Ø38mm  
Vacuum hose 8m - with 2 cuffs Ø38mm



400018

**Ref. 40002**  
BX pack 1

Manguera limpiafondos 10m - con 2 terminales Ø38mm  
Vacuum hose 10m - with 2 cuffs Ø38mm



400025



40001

**Ref. 40003**  
BX pack 1

Manguera limpiafondos 12m - con 2 terminales Ø38mm  
Vacuum hose 12m - with 2 cuffs Ø38mm



400032

**Ref. 40004**  
BX pack 1

Manguera limpiafondos 15m - con 2 terminales Ø38mm  
Vacuum hose 15m - with 2 cuffs Ø38mm



400049





90160

**Ref. 90160**  
BX pack 1

Manguera 36,5m - seccionable Ø38mm  
36,5m hose - sectionable Ø38mm



901607

**Ref. 90161**  
BX pack 1

Manguera 36,5m - seccionable Ø32mm  
36,5m hose - sectionable Ø32mm



901614



**Ref. AR2100**  
BX pack 1

Kit mangueras filtración  
Filtration hoses kit



202518



**Ref. 90165**  
CBX pack 2

Enrollador de mangueras flotantes hasta 15m.  
Manguera no incluida

Vacuum hoses roller maximum 15m. Vacuum hoses not included



901652



**Ref. 40012**  
BX pack 20



400124

Terminal manguera flotante - Ø38mm  
Hose cuff - Ø38mm



**Ref. 40009**  
BX pack 12



400094

Unión 2 mangueras flot. Ø38mm y 32mm  
2 vacuum hoses union Ø38mm and 32mm



**Ref. 40095**  
BX pack 20



400957

Adaptador de mangueras - 38/32mm  
38/32mm hose adapter



**Ref. 40091**  
BX pack 30



400919

Quitavoltas para manguera Ø 38  
38Ø hose adaptor with threaded connection



**Ref. AR509**  
CS pack 10

2 conectores Ø38 + 4 abrazaderas Ø38  
2 connectors Ø38 + 4 clamps Ø38



209685



**Ref. AR511**  
CS pack 10

2 conectores Ø38/32 + 4 abrazaderas Ø38/Ø32  
2 connectors Ø38/32 + 4 clamps Ø38/ Ø32



215792



**Ref. 60222**  
PB pack 10

Manguera de conexión 68 cm - ø38mm  
Connection hose 68 cm - ø38mm



602221

**Ref. 60218**  
PB pack 10

Manguera de conexión 58 cm - ø38mm  
Connection hose 58 cm - ø38mm



602184



**Ref. 60205**  
PB pack 10

Manguera de conexión 36 cm - ø38mm  
Connection hose 36 cm - ø38mm



602054

**Ref. 60215**  
PB pack 10

Manguera de conexión 24 cm - ø38mm  
Connection hose 24 cm - ø38mm



602153

## Racordería *PVC fittings*

1



2



1

**Ref. 40537**  
BX pack 15

Enlace Ø 50 HXH PN16  
PVC screw Ø 50 mm



405372

**Ref. 40538**  
BX pack 20

Enlace 3P. Ø 50 macho 1" 1/2 PN16  
PVC 3 piece union solvent socket Ø50mm1"1/2



405389

3



4



2

**Ref. 40539**  
BX pack 15

Enlace 3P. Ø 50 macho 2" PN16  
PVC 3 piece union solvent socket Ø 50mm 2"



405396

3

**Ref. 40541**  
BX pack 8

Válvula antiretorno Ø 50 PN16  
Check valve Ø 50 mm



405419

5



4

**Ref. 40543**  
BX pack 6

Válvula Ø 50 PN10  
PVC ball valve Ø 50 mm



405433

6



5

**Ref. 40555**  
BX pack 10

Racord curva Ø 50 90° PN16 - para encolar  
PVC elbow fitting 90° Ø 50 mm



405556

6

**Ref. 40590**  
BX pack 30

Codo Ø 50 90° PN16 - para encolar  
PVC 90° elbow solvent socket Ø 50 mm



405907

7



**Ref. 40591**  
BX pack 40

Codo Ø 50 45° PN16  
PVC 45° elbow solvent socket Ø 50 mm



405914

8



7

**Ref. 40592**  
BX pack 24

Te Ø 50 PN16 - para encolar  
PVC-Tee 90° solvent socket Ø 50 mm



405921

8

**Ref. 40593**  
BX pack 60

Racord Ø 50 PN16 - para encolar  
PVC union solvent socket Ø 50 mm



405938

9



9

**Ref. 40646**  
BX pack 8

Válvula Ø 50 PN10, tubo filetato maschio  
Ball valve Ø 50 mm



406461

10



10

**Ref. 40557**  
PB pack 1

Tubo PVC semirígido Ø 50, 25m  
Semi-rigid PVC hose Ø 50 mm, 25m



405570

**Ref. 40553**  
BX pack 12

Adhesivo para PVC 250 g  
Blue Adhesive for flexible PVC pipes 250 g



405532





## Protección invierno Winter protection



**Ref. 40580**  
BX pack 10

Flotador de invernaje  
Winterising float



405808



**Ref. 40581**  
BX pack 35

Gizmo - protección del skimmer  
Gizmo - skimmer protectionr



405815



**Ref. 40582**  
BX pack 30

Tapón de invernaje 1,5"  
Winterising plug 1,5"



405822



**Ref. 40583**  
BX pack 30

Tapón de invernaje 2"  
Winterising plug 2"



405839



**Ref. 09150**  
BX pack 14

Kit de protección de skimmer para piscinas elevadas  
Skimmer protection kit for above-ground pools



091506



# Producto químico Chemicals





## Pasos para cuidar de su piscina Steps to take care of your swimming pool



<p><b>¿Cómo? How?</b></p>	<p>Minorador de pH pH reduce</p> <p>Incrementador de pH pH increase</p>	<p>Cloro choque Shock chlorine</p>	<p>Cloro lento Slow chloration</p>	<p>Bromo Bromine</p>	<p>Oxígeno activo Active oxygen</p>
<p><b>¿Para qué? Why?</b></p>	<p>Obtener un pH entre 7,2 y 7,6 To have a pH value between 7,2 and 7,6</p>	<p>Desinfectar rápidamente y destruir los organismos, hongos y bacterias To disinfect quickly and to eliminate all the organisms and bacteria</p>	<p>Desinfectar permanentemente To have a permanent disinfection</p>		<p>Desinfectar permanentemente To have a permanent disinfection</p>
<p><b>¿Cuándo? When?</b></p>	<p>A diario Daily</p>	<p>Al inicio de temporada At the beginning of the swim season</p> <p>Después de condiciones climáticas extremas After bad weather conditions</p> <p>Uso intensivo de la piscina High use level</p>	<p>A diario Daily</p>		<p>A diario Daily</p>
<p><b>Resultado Result</b></p>	<p>pH ideal para la piel y los ojos. Instalaciones en perfecto estado Ideal pH for skin and eyes. Good conditions equipment</p>	<p>Agua limpia y libre de posibles contagios Clean water without contagious risk</p>	<p>Agua limpia y libre de posibles contagios Clean water without contagious risk</p>		<p>Agua limpia y libre de posibles contagios Clean water without contagious risk</p>



**Tratamiento antialgas**  
Anti-algae treatment

4

**Floculación**  
Flocculation

5



**Completo 4 Acciones**

**Total 5 Acciones**

**Total 10 Acciones**

	<p>Antialgas concentrado Concentrated algaecide</p> <p>Antialgas Extra Extra anti-algae</p>	<p>Floculante Flocculant</p>
<p>Prevenir la aparición de algas To avoid algae apparition</p> <p>Eliminar las algas existentes To eliminate the algae</p>	<p>Eliminar las partículas en suspensión To eliminate particles in suspension</p>	
<p>Según convenga Depending on water quality</p>	<p>Semanalmente Weekly</p>	
<p>Agua sin algas Water without algaes</p>	<p>Agua cristalina Crystaline water</p>	

Fórmula innovadora que permite en una sola aplicación, eliminar bacterias, virus y microorganismos en general  
Thanks to its new formula, you can eliminate bacteria, virus and microorganisms

<p><b>4 funciones:</b> Cloro Antialgas Estabilizante Floculante</p>	<p><b>4 funciones:</b> Chlorine Antialgae Stabiliser Flocculant</p>
<p><b>5 funciones:</b> Cloro Antialgas Estabilizante Floculante <b>Anticalcáreo</b></p>	<p><b>5 funciones:</b> Chlorine Antialgae Stabiliser Flocculant <b>Anti lime</b></p>

<p><b>10 funciones:</b></p> <ul style="list-style-type: none"> <li>- Bactericida</li> <li>- Floculante</li> <li>- Coagulante</li> <li>- Algicida</li> <li>- Algistático</li> <li>- Regulador de pH</li> <li>- Estabilizante de cloro</li> <li>- Anticalcáreo</li> <li>- Viricida</li> <li>- Fungicida</li> </ul>	<p><b>10 functions :</b></p> <ul style="list-style-type: none"> <li>- Germicide</li> <li>- Flocculent</li> <li>- Coagulant</li> <li>- Algicide</li> <li>- Algistatic</li> <li>- pH regulator</li> <li>- Chlorine stabilizer</li> <li>- Anti-Limescale Agent</li> <li>- Virucide</li> <li>- Fungicide</li> </ul>
--	---

Producto químico de la marca GRE, especial para uso en piscinas sobre suelo  
 GRE brand chemicals, especially for use in above-ground pools



**pH plus**

- 

Ref. **20015** Incrementador de pH  
 Granulado  
 pH increase  
 Granules  
 8412081240992  
 1 Kg pack 12
- 

Ref. **20021**  
 8412081244143  
 5 Kg pack 4

**pH minus**

- 

Ref. **20016** Minorador de pH - Granulado  
 pH reduce - Granules  
 8412081241005  
 1,5 Kg pack 12

**clorchoc**

- 

Ref. **20020** Cloro choque - Granulado  
 Shock chlorine - Granules  
 8412081244136  
 1 Kg pack 12
- 

Ref. **20019**  
 84120812441295  
 5 Kg pack 4
- 

Ref. **20023** Cloro choque - Pastillas 20 gr  
 Shock chlorine - 20 gr tablets  
 8427370200236  
 1 Kg pack 12
- 

Ref. **20024**  
 8427370200243  
 2,5 Kg pack 4





## Especial liner Special liner



5



6



7



8



### complet 4 actions

### antialg

Ref. **20005**

Pastillas 20g  
20 gr tablets

8412081240893  
1 Kg pack 12

Ref. **20011**

Antialgas  
Anti algae

8412081240954  
1 l pack 12

Ref. **20006**

Tabletas 200 gr  
200 gr tablets

8412081240909  
2,5 Kg pack 4

Ref. **20012**

8412081240961  
3 l pack 4

Ref. **20007**

8412081240916  
5 Kg pack 4

6

Ref. **20014**

Kit piscinas infantiles  
Kit for children's pools

8412081240985  
1,2 Kg pack 14

Cloro choque granulado 500 g + Algicida 500 ml  
Shock chlorine granules 500gr +Anti algae 500ml

### floculant

Ref. **20017**

Floculante líquido  
Liquid flocculant

8412081241012  
1 l pack 12

Ref. **20022**

8412081244150  
5 l pack 4

## Cálculo de volumen de agua

Para un correcto suministro del producto químico, es importante calcular el volumen de agua de la piscina.

## Calculate the pool water volume

It is important to calculate the pool water volume to do a correct chemical treatment.

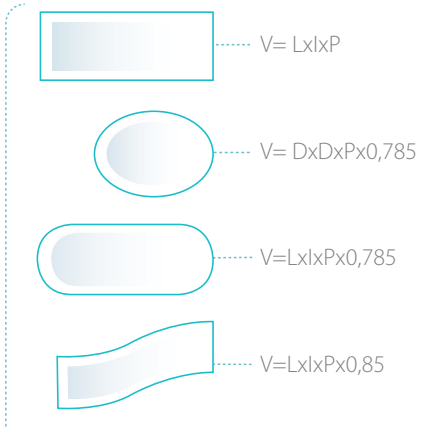

**Ejemplo Example**

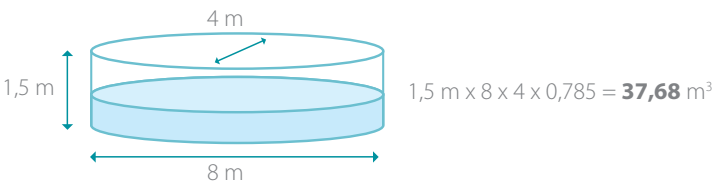

**V** Volumen en m<sup>3</sup>  
Volume in m<sup>3</sup>

**L** Longitud en m  
Length in m

**I** Anchura en m  
Width in m

**D** Diámetro en m  
Diameter in m

**P** Profundidad en m  
Depth in m

## Leyenda Legend

 500 g	 10 Kg	 10 L
 240 g / 400 g / 1 Kg / 1,5 Kg	 1 L	 1 L
 2,5 Kg	 3 L	 1Kg
 5 Kg	 5 L	





## 2 Desinfectantes 3 Disinfectants

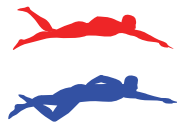

Para poder tener un agua transparente y en definitiva libre de posibles contagios, es imprescindible que ésta sea desinfectada regularmente. Los desinfectantes pueden ser de diversos tipos, siendo los más comunes los productos clorados, aunque también existen otras soluciones alternativas, igualmente con un elevado poder desinfectante, como el bromo o el oxígeno activo.

In order to have clear water without contagious danger, it is necessary to treat it regularly. There exist several kind of disinfectants, whose most common is chlorine. Other solutions like bromine or oxygen have also a high disinfection action.

## 2 Cloro choque Shock chlorine

El Cloro Choque permite destruir rápida y eficazmente todos los organismos, hongos y bacterias. Conviene realizar una cloración de choque: Al inicio de la temporada de baño / Después de condiciones climáticas extremas / En caso de uso intensivo de la piscina

It eliminates quickly all the organisms and bacteria. It is necessary to do a Shock chlorination: At the beginning of the swim season / After bad weather conditions / High use level



## 3ª Cloro Lento Trichlorine

Para conseguir una desinfección preventiva y continua del agua, es necesario mantener una tasa de cloración libre. Por ello, conviene efectuar una cloración permanente o "cloración lenta".

To have a preventive and continue disinfection, it is necessary to keep a free chlorination value. For this reason, people must do a permanent chlorination or a "slow chlorination".

clorchoc	
	8427370 08482 9 1 Kg pack 12 <b>Pastillas 20 gr 20 gr tablets</b>
	8427370 08485 0 5 Kg pack 4
	8427370 05203 3 5 Kg pack 42 <b>1/2 box palet</b>
	Con un 50% de cloro activo mínimo (triclora) Disolución instantánea Minimum 50% active chlorine (trichlorine) Instant dissolution
	8427370 05916 2 1 Kg pack 12 <b>Granulado Granules</b>
	8427370 05917 9 5 Kg pack 4
	Con un 55% de cloro activo mínimo. Disolución rápida Minimum 55% active chlorine. Quick dissolution

clorlent	
	8427370 05922 3 1 Kg pack 12 <b>Pastillas da 200g 200 gr tablets</b>
	8427370 05923 0 5 Kg pack 4
	8427370 05920 9 1 Kg pack 12 <b>Granulado Granules</b>
	8427370 05921 6 5 Kg pack 4



3

4



5



### 3<sup>b</sup> Bromo Bromine

Diferencias respecto al cloro: menos olor, no daña la piel ni el cabello. Más eficacia en las aguas calientes y/o calcáreas.  
Differences compared to chlorine: less smell, does not dry out skin and hair. More efficient in hot and/or calcareous water

#### brom'lent



8427370 05531 7  
1 Kg pack 12

**Pastillas 20g  
20 gr tablets**



4 8427370 05526 3  
5 Kg pack 4

#### brome choc



3 8427370 05508 9  
5 Kg pack 4

**Granulado  
Granules**

#### Brom multiactions



8427370 30198 8  
5 Kg pack 4

**Bromo multi-Acciones  
pastillas 20 gr  
Bromine multi-Actions  
20 gr tablets**

### 3<sup>c</sup> Oxígeno activo Active oxygen

Ofrece muchas ventajas, ya que proporciona una desinfección muy eficaz y a diferencia del cloro, no provoca irritaciones oculares ni desprende olores desagradables. Producto que necesita de un dosificador.

This product offers a lot of advantages. It disinfects pool water and contrary to chlorine, it does not cause eye irritation neither and bad smells. This product needs a dispenser.

#### acti oxy



8427370 05660 4  
1 L pack 12

**Activador O<sub>2</sub> y microbicida  
Active O<sub>2</sub> algacide**



5 8427370 05936 0  
5 L pack 4

#### oxy choc



8427370 05938 4  
5 L pack 4

**Oxígeno choque  
Shock oxygen**

#### oxy lent



8427370 05937 7  
1,2 Kg pack 12

**O<sub>2</sub> activo · pastillas 20 gr  
O<sub>2</sub> oxygen · 20 gr tablets**



8427370 05661 1  
2,5 Kg pack 4

## Multifunciones Multiactions



Se trata de un **producto revolucionario**, ya que gracias a su fórmula innovadora permite en una sola aplicación, eliminar las bacterias, virus y microorganismos en general, evitar el desarrollo de algas, al mismo tiempo que mantiene transparente y cristalina el agua.

**Revolution product:** Thanks to its new formula, you can eliminate bacteria, virus and micro organisms, avoid algae and have clear and crystalline water.





Complet 4 actions :

**Cloro + Antialgas + Estabilizante + Floculante**  
**Chlorine + Antialgae + Stabiliser + Flocculant**



complet 4 actions		
	8427370 07621 3 0,5 Kg pack 48	<b>Bloque 500 gr - 1 bloque</b> <b>500 gr block - 1 block</b>
	8427370 05520 1 1 Kg pack 12	<b>Pastillas da 200g</b> <b>200 gr tablets</b>
	8427370 06641 2 5 Kg pack 4	
	8427370 05521 8 10 Kg pack 2	
	8427370 05200 2 5 Kg pack 42	<b>1/2 box palet</b>
	8427370 05523 2 1 Kg pack 12	<b>Pastillas da 20g</b> <b>20 gr tablets</b>
	8427370 05524 9 5 Kg pack 4	
	8427370 05522 5 5 Kg pack 4	<b>Granulado</b> <b>Granules</b>

### complet 4 actions - special liner

	8427370 05662 8 1 Kg pack 12	<b>Pastillas da 200g</b> <b>200 gr tablets</b>
	8427370 05663 5 5 Kg pack 4	
	8427370 05664 2 10 Kg pack 2	
		Sin sulfato de cobre Without copper sulphate

### Complet 5 actions

**Cloro + Antialgas + Estabilizante + Floculante + Antical**  
**Chlorine + Antialgae + Stabiliser + Flocculant + Anti lime**

	8427370 06640 5 5 Kg pack 4	<b>Pastillas da 200g</b> <b>200 gr tablets</b>
	8427370 06642 9 10 Kg pack 2	



## Multi funciones doble capa Two-layer multiactions



Total 10 actions :



**Desinfectante + Bactericida + Floculante + Coagulante + Algicida + Algistático + Regulador de pH + Estabilizante de cloro + Anticalcáreo + Virucida + Fungicida**

**Disinfectant+ Germicide + Flocculent + Coagulant + Algicide + Algistatic + pH regulator + Chlorine stabilizer + Anti-Limescale Agent + Virucide+ Fungicide**

### complet 10 actions

 **3** 8427370 05527 0 **Pastillas da 250g  
250 gr tablets**  
2,5 Kg pack 4

 **4** 8427370 05525 6 **Pastillas da 250g  
250 gr tablets**  
5 Kg pack 4

### Multiactions + Choc

**Cloro multifunción + choque  
Multiactions + shock chlorine**

 8427370 06646 7 **Pastillas bicapa 250g  
250 gr Two-layer tablets**  
1 Kg pack 6

 8427370 05665 9  
2,5 Kg pack 4

 **5** 8427370 06643 6  
5 Kg pack 4

### Multiactions + Antical

**Cloro multifunción + anticalcáreo  
Multiactions + anti lime chlorine**

 **6** 8427370 06644 3 **Pastillas bicapa 250g  
250 gr Two-layer tablets**  
5 Kg pack 4



## 4 Tratamiento antialgas Anti-algae treatment



Las algas son organismos vegetales unicelulares que pueden desarrollarse y multiplicarse rápidamente en el agua, sobre todo cuando su temperatura es templada.  
Algae are vegetal unicellular organisms that can quickly develop and multiply themselves in the water, specially when the temperature of the water is warm.

### stop eaux vertes



8427370 05510 2  
5 L pack 4

**Stop aguas verdes**  
**Stop green waters**

Oxígeno activo: acción sin cloro  
Active oxygen: without chlorine

### antialg



8427370 05926 1  
1 L pack 12

**Antialgas**  
**Anti algae**



1 8427370 05927 8  
5 L pack 4

8427370 05202 6  
5 L pack 48

**1/2 box palet**

Para prevenir la aparición de algas.  
To prevent the appearance of algae

### antialg xtra



8427370 05928 5  
1 L pack 12

**Antialgas Extra**  
**Extra anti algae**



2 8427370 05929 2  
5 L pack 4

3 acciones. Extra: para eliminar todas las algas.  
3 actions. Extra: to eliminate the algae.



## 5 Floculante Flocculant



La floculación permite obtener un agua cristalina. Existen dos tipos de floculación: la que se realiza dentro del filtro y la floculación dentro del vaso. La primera permite aumentar la fineza de filtración y eliminar de esta manera las partículas más finas. Ésta se efectúa gracias a los cartuchos floculantes (incompatibles con filtros de cartucho) colocados en el cesto del skimmer. La segunda permite agrupar entre ellas las impurezas que no pueden ser filtradas individualmente y que son el origen de un agua turbia. Esta operación se efectúa con el floculante líquido.

Flocculation allows to obtain a crystalline water. There are two kind of flocculation: inside the filter and in the pool. With the first one we increase the fineness of filtration in order to eliminate smaller particles. For this process we introduce flocculants cartridges (incompatible with cartridge filters) in the skimmer basket. The second one helps us to group all the impurities that are the beginning of brown water thanks to liquid flocculant.

### super floculant

**3** 8427370 05666 6  
200 gr pack 24 **10 Tabletas de 20 gr  
20 gr 10 tablets**

Tabletas de floculante superconcentradas  
Super-concentrated flocculant tablets

### floculant

**5** 8427370 05932 2  
1 L pack 12 **Floculante líquido  
Liquid flocculant**

**6** 8427370 05933 9  
5 L pack 4



Para clarificar el agua y eliminar las materias en suspensión. Recupera el agua turbia.  
To clarify water and eliminate substances in suspension Retrieve the cloudy water

**4** 8427370 07445 5  
1 Kg pack 14 **Cartuchos floculantes  
125g  
Flocculant cartridges  
125g**

Para mejorar la calidad de filtración (filtros de arena únicamente). Producto de mantenimiento.  
To increase filtration quality (sand filters only).  
Product Maintenance.

## Productos complementarios Complementary products



detrartrant surface	
	8427370 08487 4 1 L pack 12 <b>Desincrustante de superficie</b> <b>Surface descaler</b>
	8427370 05930 8 5 L pack 4
	8427370 08490 4 1 L pack 12 <b>Gel limpiador antical</b> <b>Cleansing Anti-Limescale Gel</b>
<p>Per evitare la incrostazione del calcare To eliminate lime scales</p>	
	8427370 08491 1 6 kg pack 4 <b>Neutralizador de cloro/ bromo</b> <b>Chlorine/bromine Neutralizer</b>
<p>Para eliminar el exceso de cloro/bromo residual To eliminate the excess residual chlorine/bromine</p>	

anticalc	
	8427370 08488 1 1 L pack 12 <b>Anticalcáreo</b> <b>Anti lime</b>
	8427370 08489 8 5 L pack 4
<p>Para evitar la formación de cal. Secuestrante de metales (hierro, cobre...) To prevent lime formation. Metal Sequestering Agents (iron, copper...)</p>	
nettoyant ligne d'eau	
	8427370 05931 5 1 L pack 12 <b>Limpiador de bordes</b> <b>Waterline cleaner</b>
<p>Para eliminar la suciedad de la línea de flotación To eliminate the dirt on the waterline</p>	



## Producto químico para el invierno Chemical products for winter

Le facilitará la puesta en marcha de la piscina después del invierno, evitando la formación de algas y de cal.  
Realizar el proceso cuando la temperatura del agua de la piscina sea inferior a 15°C.

- 1) Limpiar la piscina.
- 2) Ajustar el pH entre 7,2 - 7,6
- 3) Realizar una cloración de choque
- 4) Dejar en funcionamiento el filtro hasta el día siguiente
- 5) Realizar una limpieza del filtro
- 6) Añadir el invernador

It makes easier for you the start-up of the pool after winter, avoiding algae and lime formation.  
Please carry out the following if the temperature of the water drops below 15°C.

- 1) Clean the swimming pool
- 2) Set the pH balance between 7.2 – 7.6
- 3) Carry out a chlorine crash course
- 4) Leave the filter running until the following day
- 5) Clean the filter
- 6) Add the winterizing agent



hibernage

 8427370 07446 2  
1 L pack 12

**Invernador**  
**Winteriser**

 **4** 8427370 07449 3  
5 L pack 4



Hiver float

 **5** 8427370 05528 7  
2 kg pack 6

**Invernador con boya**  
**Float winteriser**



nettoyant ligne d'eau



NLA100  
3760120430329  
display 12 u.

**Limpiador línea de agua con aplicador**  
**Waterline cleaner with applicator**

Anti insect



3760120430275  
Cod. 90178  
180 g pack 12

**Caja de 6 pastillas de 30g**  
**30g 6 tablet box**

Repulsivo Anti Insectos a base de aceites esenciales 100% naturales  
Anti Insect repellent using 100% natural essential oils



3760120430305  
Cod. 90175  
90 g pack 24

**Dosificador de 3 pastillas de 30g**  
**30 g 3 tablet dosifier**

Repulsivo Anti Insectos a base de aceites esenciales 100% naturales  
Anti Insect repellent using 100% natural essential oils



## Specific treatments



3760120430282 **Stop Aguas Verdes**  
Cod. 90147  
120g pack 12

Recupera las aguas verdes gracias a una nueva generación de polimeros hidrosolubles  
Get back the green waters of your pool thanks to a new generation of water soluble polymers



3760120430299 **Stop Aguas Turbias**  
Cod. 90143  
120g pack 12

Recupera las aguas turbias, y consigue un agua limpia y cristalina  
Get back the cloudy waters to obtain a cristal-clear water



3760120430343 **Stop Aguas Turbias**  
Cod. SATC6  
120g pack 12

Para piscinas con filtro de cartucho  
For pools with cartridge filter

## Soluciones de tratamiento Treatment solutions



8427370 08730 1  
pack 12

**Kit para piscina de 0 a 5m<sup>3</sup>**  
**Kit for 0-5m<sup>3</sup> pool**

Cloro lento pastillas de 5 g - 500 g + Dosificador + Pelota  
Trichlorine 5g tablets - 500 g + Dispenser + Ball



8427370 08731 8  
pack 6

**Kit para piscina de 5 a 15m<sup>3</sup>**  
**Kit for 5-15m<sup>3</sup> pool**

Multifunciones pastillas 20g - 1Kg + Dosificador + Termómetro +  
Analizador + Manguitos + Kit reparación liner  
Multiactions 20g tablets - 1Kg + Dispenser + Thermometer +  
Test kit



8427370 08732 5  
pack 4

**Kit para piscina de 15 a 30m<sup>3</sup>**  
**Kit for 15-30m<sup>3</sup> pool**

Multifunciones pastillas 20g - 2.5Kg + Cloro choque granulado 2,5  
Kg + Termómetro + Analizador  
Multiactions 20g tablets - 1Kg + Shock chlorine granules - 2,5Kg +  
Dispenser + Thermometer



8412081241890  
KITSPA  
pack 2

**Kit para Spa  
Kit for Spa**

Oxígeno tabletas 20gr (1kg) + Minorador de pH granulado (1,5kg) + Antiespumante (500ml) + Algicida no espumante (1l) + Anticalcáreo (500ml) + Estuche analizador Cl/Br/Ox/pH  
Oxygen 20gr tablets (1kg) + pH reduce granules (1,5kg) + Antifoam (500ml) + Non-foaming algaecide (1l) + Anti lime (500ml) + Cl/Br/Ox/pH test kit



8412081250885  
08099  
pack 9

**Dosificador flotante con tratamiento químico - 3 semanas  
Chemical treatment floating dispenser - 3 weeks**

**POOLP'O 10-30 m<sup>3</sup>  
(700g)**



8427370 08013 5  
pack 16

**POOLP'O 10-20 m<sup>3</sup>  
(500g)**



8427370 08012 8  
pack 16

**POOLP'O 0-10 m<sup>3</sup>  
(250g)**

- Solución de tratamiento "Todo en Uno". Ideal piscinas elevadas con o sin filtración. Tratamiento mensual.  
- 4 Acciones: Desinfectante, Antibacterias, Antialgas y Floculante  
- No hay manipulación directa de producto químico. No perjudica la filtración gracias a su forma optimizada que deja el circuito de agua intacto. El POOLP'O sube a la superficie una vez acabado el producto químico, avisando de la necesidad de empezar un nuevo tratamiento.-

Treatment solution "All in One" for Above ground Pools with and without filtration. Monthly treatment.  
- 4 actions: Disinfecting, Anti-bacteria, Anti-algae and Flocculant.  
- No direct handling of chemical product. It does not obstruct filtration thanks to its form optimized – which leaves the circuit of water intact. It goes up once product finished, so you know you should start a new treatment.



## Analizadores Test kits



**Ref. 40060**  
DIS 1/2N BL pack 32

Analizador de cloro/bromo + pH (Oto/Phenol)  
Test kit chlorine/bromine + pH (Oto/Phenol)



400605



**Ref. 40061**  
DIS 1/8 BL pack 24

Recambio Oto/Phenol  
Refill Oto/Phenol



400612



**Ref. 40062**  
DIS 1/8 CS pack 24

Comparador cloro + pH - pastillas DPD1  
Test kit chlorine + pH - DPD1 tablets



400629



**Ref. 40063**  
DIS 1/8 BL pack 24

Recambio pastillas DPD1  
Refill DPD1 tablets



400636



**Ref. 40066**  
DIS 1/8 CS pack 24

Kit de análisis de oxígeno/bromo + pH - pastillas DPD4  
Oxygen / bromine + pH test kit - DPD4 tablets



400674



**Ref. 40067**  
DIS 1/8 BL pack 24

Recambio pastillas DPD4  
Refill DPD4 tablets



400674



**Ref. TD61**  
CS pack 8

Tester digital de 6 lecturas: pH, Cloro libre, Salinidad, TDS (Tasa total de solidos disueltos en el agua), ORP, Temperatura  
6 readings digital tester: pH, FC (free chlorine), Salinity, TDS (Total disolve solids), ORP, Temperature



241067



**Ref. TDS10**  
CS pack 8

Tester digital para piscinas y spas  
Mide el nivel de sal en el agua y la temperatura  
Digital salt tester for pools and spas.  
Designed to test water salt in pools and spas.



250878

## Tiras de análisis Test strips



**Ref. 40068**  
DIS 1/8 BL pack 16

Análisis cloro + pH + alcalinidad  
Chlorine + pH + alkalinity analysis (50 strips)



400681



**Ref. 40069**  
BX pack 12

Analiza el nivel de sal en el agua  
Salt level in water analysis



400698

## Material POS - POS Material

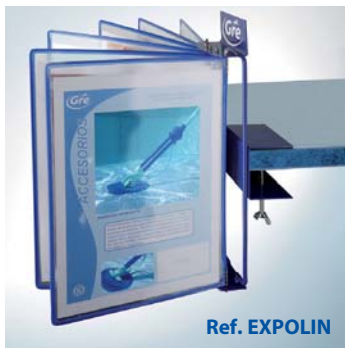

Volantini Leaflets

# www.gre.es

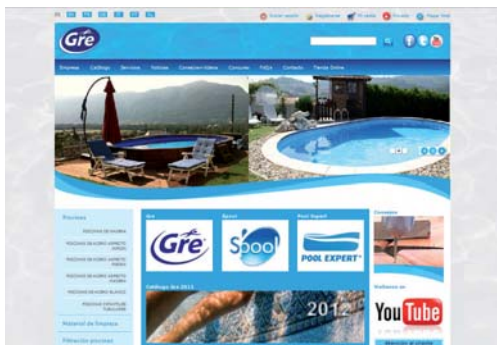

HOME PAGE: - PRODOTTI ELENCATI - PRODOTTI PIÙ VISITATI - NOVITÀ - CATALOGO...

HOME PAGE - MOST SOLD PRODUCTS - MOST VISITED PRODUCTS - NEW PRODUCTS - CATALOGUE...

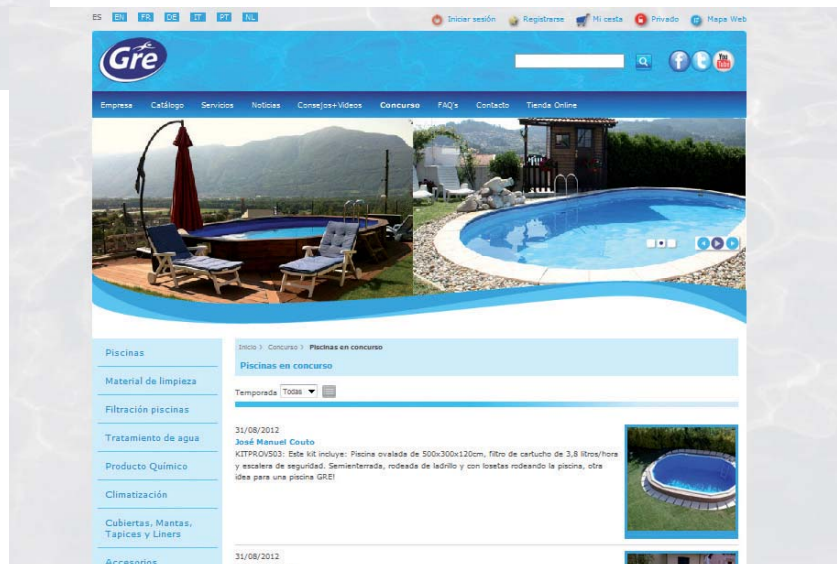



Nos reservamos el derecho de cambiar total o parcialmente las características de nuestros artículos o el contenido de este documento sin previo aviso  
Fotos e imágenes no contractuales  
We reserve the right to change all or part of the articles or contents of this document without prior notice  
Photos and pictures are not contractual





**MANUFACTURAS GRE S.A.**

ARITZ BIDEA Nº57 | BELAKO INDUSTRIALDEA  
APARTADO 69 | 48100 MUNGIA (VIZCAYA) SPAIN

TLF: (34) 946 741 116

FAX: (34) 946 741 708

email: gre@gre.es

[www.gre.es](http://www.gre.es)